

APACHE Series LED



PROJECT NAME	
CATALOG #	
NOTES	

FEATURES

- > 2ft and 4ft lengths available
- > Meanwell Driver
- > High efficacy: up to 140 lm/W
- > CRI>70
- > Standard 120-277V. Available Options also include
 - 277-480V
 - 12-36VDC
- > Temp Rating for 20-80W Models: -40°C to 60°C (-40°F to 140°F)
- > Temp Rating for 90-120W Models: -40°C to 40°C (-40°F to 104°F)
- > Three connection cable entry
- > Aircraft Aluminum Housing with Marine Die-Cast Powder Finish Coat
- > Adjustable
- > Standard 10KV surge protection
- > Standard integrated junction box
- > 1.5 - 3 Hour Emergency Operation (optional)
- > 5 or 10 Year Limited Warranty (specified in part number)

APPLICATIONS

- > Power Plants / Heavy Industrials
- > Distillery, Alcohol
- > Paper Mills / Wastewater Treatment Plants
- > Loading Docks / Platforms / Shipyards
- > Chemical Processing Facility
- > Mining
- > Ocean Marine
- > LNG facilities
- > Metal Industry



BAA and TAA available. Contact factory for more information and pricing.

COMPLIANCE

UL 844 Hazardous Locations North America

- > Class I, Division 1, Group C,D
- > Class I, Division 2, Groups A, B, C & D
- > Class II, Division 2, Groups F & G
- > Class III

Other Markings/Standards

- > UL 1598 Wet Locations
- > UL 8750 LED Safety
- > DLC Listed
- > CSA C22.2 No. 250.0-08
- > CSA C22.2 No. 137-M1981

APACHE ORDERING INFORMATION

SAMPLE ORDER NUMBER: APA-4-1-8-1-3-1-1-2-X

SERIES	LENGTH	LENS	WATTAGE	VOLTAGE	CCT	OPTIC	DRIVER	WARRANTY	OPTIONS
APA	2- 2 feet	1- Glass	2- 20W	1- AC 120-277V	1- 3000K	1- 120°	1- Dim	5- 5 Year	X- None
	4- 4 feet		3- 30W	2- AC 277-480V	2- 4000K			10- 10 Year	1- EMB
			4- 40W	3- DC 12-36V	3- 5000K				2- Custom Cable Length
			5- 50W		4- 6000K				3- Junction Box
			6- 60W						4- BAC*
			8- 80W						5- TAC*
			10- 100W						
			12- 120W						

* BAC = Buy American Compliant | TAC* = Trade Agreements Act Compliant

APACHE Series LED

LUMINOUS OUTPUT & DIMENSIONS

WATTAGE	3000K	4000K	5000K	6000K	DIMENSIONS
20 Watts	2,000 lumens	2,560 lumens	2,700 lumens	2,800 lumens	2 foot - 23.3" x 9.1" x 5.5"
30 Watts	3,600 lumens	3,840 lumens	4,050 lumens	4,200 lumens	
40 Watts	4,800 lumens	5,120 lumens	5,400 lumens	5,600 lumens	
50 Watts	6,000 lumens	6,400 lumens	6,750 lumens	7,000 lumens	
60 Watts	7,200 lumens	7,680 lumens	8,100 lumens	8,400 lumens	
80 Watts	9,600 lumens	10,240 lumens	10,800 lumens	11,200 lumens	
100 Watts	12,000 lumens	12,800 lumens	13,500 lumens	14,000 lumens	
120 Watts	14,400 lumens	15,360 lumens	16,200 lumens	16,800 lumens	

PRODUCT DIMENSIONS

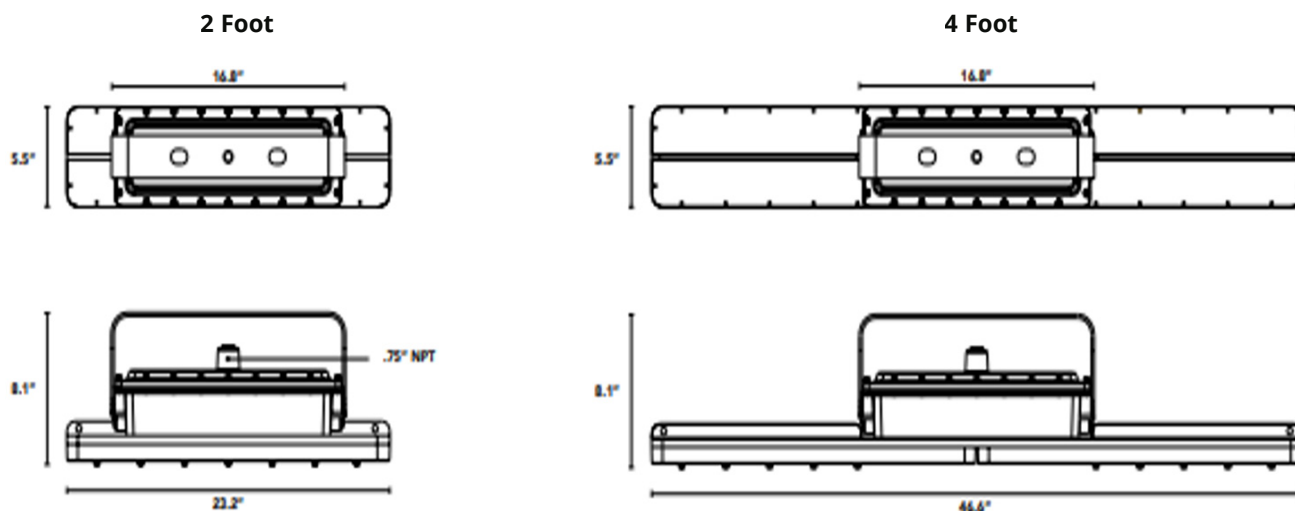

LIGHT DISTRIBUTION

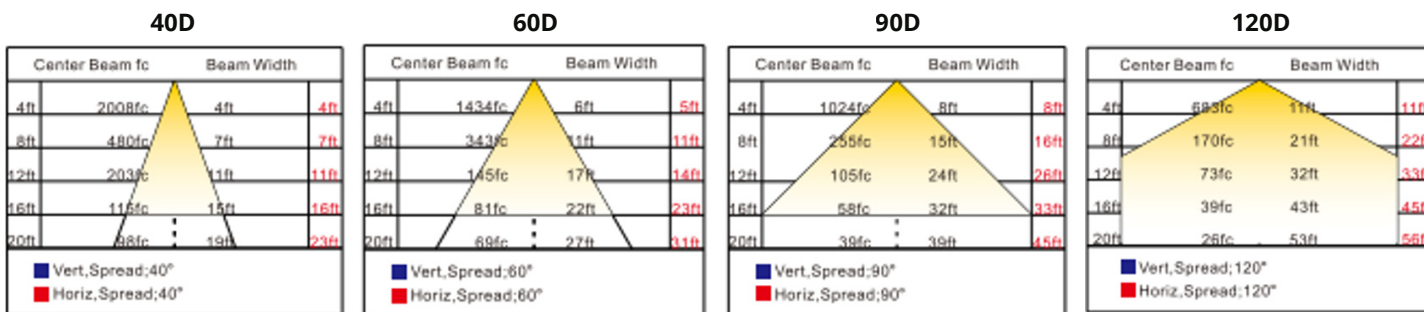

APACHE Series LED

MOUNTING OPTION INSTRUCTIONS



⚠ WARNING
Risk of fire, Electric shock or personal injury
Please turn off power before installation!

> Chain Mounting

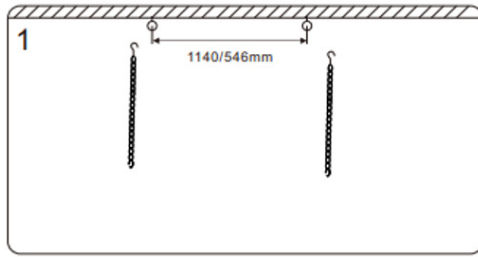

1. Drill 2x hole for hanging ring (1140mm for 4FT fixture or 546mm for 2FT fixture), and fixing them.

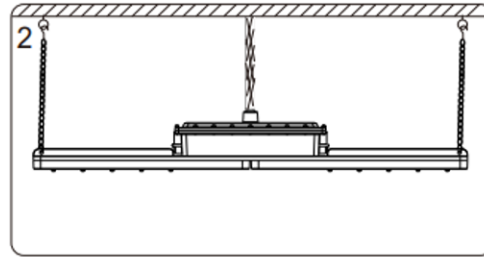

2. Fix the hanging chain to light fixture. Wire the cable through the metal conduit and then connect it with the power.

> Pole Mounting

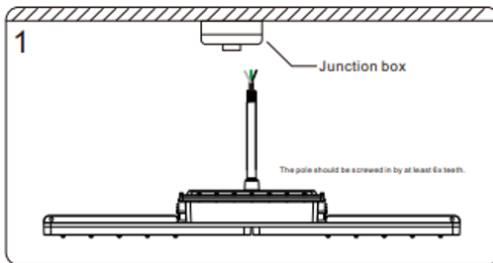

1. Wire the cable through the pole and then install the pole to the fixture.

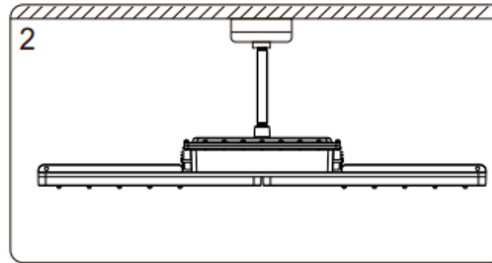

2. Wire the cable to enclosure of junction box and install the pole to junction box.

> Bracket Mounting

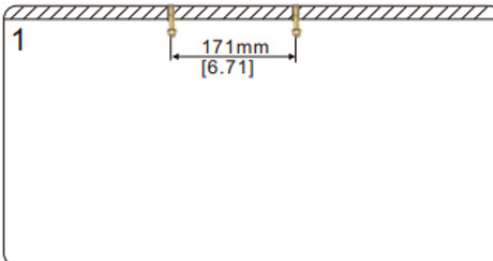

1. Drill 2x Ø15 holes for expanded screws, and fix them to the ceiling.

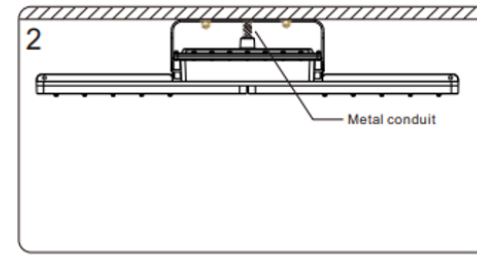

2. Install the fixture to the expanded screws, and tighten the nuts. (Metal conduit need to apply here)

> Pole Bracket Mounting

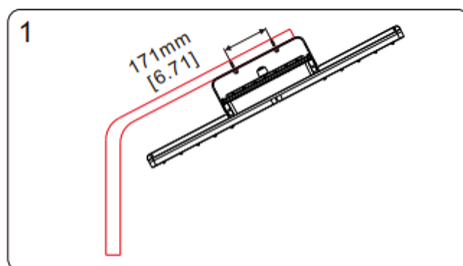

1. Drill 2x Ø15 holes for fixing screws.

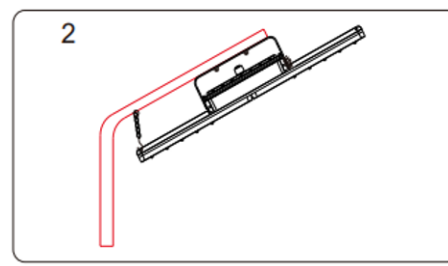

2. Fix the pendant chain and hook the fixture. Insert 2x Ø15 fixing screws and weld them on the pole bracket with the fixture.

> Wall Mounting



1. Drill 2x Ø15 hole for expanded screws, and fix them to the wall. (Horizontal distance: 171mm)

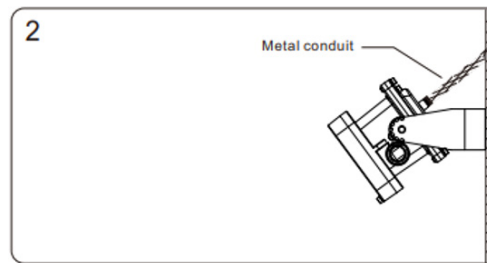

2. Install the fixture to wall and connect the wire to AC power. (Metal conduit needs to apply here)