

# SHIELD Series LED



## APPLICATIONS

- > Power Plants / Heavy Industrials Storage Facility
- > Paper Mills / Wastewater Treatment Plants
- > Loading Docks / Platforms / Shipyards
- > Chemical Processing Facility
- > Petrochemical Processing Facility
- > Mining
- > Ocean Marine
- > LNG facilities
- > Metal Industry
- > Food and distilling
- > Alcohol Industry
- > Steel and aluminum factories



BAA and TAA available. Contact factory for more information and pricing.

PROJECT NAME	
CATALOG #	
NOTES	

## FEATURES

- > Heavy-duty and high impact resistance
- > Four connection cable entry points
- > Dimmable and non-dimmable options available.
- > Emergency battery backup available with integrated junction box for driver.
- > Tempered glass lens standard with opal globe and guard.  
Options include:
  - Flat Glass Lens
  - Dome Reflector
  - Angle Reflector
- > Standard 120-277V, Available options include:
  - 12-36VDC
- > Operating Temperature: -20°C - 60°C (-4°F - 140°F)
- > Housing: Copper Free A383 Die Cast Aluminum
- > Gasketing: Fluorosilicone Rubber
- > Hardware: Stainless Steel 304
- > Finish: Polyester Powder coat
- > Lens: Tempered Glass
- > LED Chips: Philips
- > Driver: Meanwell
- > Surge Protection: 10KV
- > Expected Life: Over 85,000 hrs.
- > Color Rendering Index (CRI): 70

## COMPLIANCE

### UL 844 Hazardous Locations North America

- > Class I, Division 2, Groups A, B, C, D
- > Class II, Division 1, Groups E, F, G
- > Class II, Division 2, Groups F, G
- > Class III

### Other Ratings

- > NEMA 4X, IP66, IK10, UL1598A Marine Vessels, UL924 Emergency Lighting

## SHIELD ORDERING INFORMATION

SAMPLE ORDER NUMBER: SHI-2-1-3-1-1-1-3-OPEB

SERIES	WATTAGE	VOLTAGE	CCT	OPTIC	DRIVER	WARRANTY	OPTIONS	MOUNTING/ACCESSORIES
SHI	1- 10W	1- AC120-277V	1- 3000K	1- 120°	1- 0-10V Dim	5- 5 Year	X- None	X- None
	2- 20W	2- 12-36VDC	2- 4000K	2- 90°	2- Non-Dim	10- 10 Year	1- Flat Glass Lens	OPEM- Junction Box
	3- 30W		3- 5000K	3- 60°			2- Clear Globe	OPCM- Ceiling/Surface Mount Junction Box <sup>3/4"</sup> NPT
	4- 40W		4- 6000K	4- 40°			3- Frosted Globe	OPWA- 90° Wall Mount
							4- Wire Guard	
							5- Clear Globe w/ Wire Guard	
							6- Frosted Globe w/ Wire Guard	
							7- Dome Reflector	
							8- Angle Reflector	
							9- Buy American Act Compliant	
							10- Trade Agreements Act Compliant	

# SHIELD Series LED

## MOUNTING ACCESSORIES



> Ceiling Mount  
(Shown on fixture)



> Wall Mount  
(Shown on fixture)



> Ceiling/Wall Mount



> Ceiling/Wall  
(Interior)



> Pendant Mount



> Wall Elbow



> Reflector



> Extension



> Globe



> Guard



> Heat Sink

# SHIELD Series LED

## PHOTOMETRICS

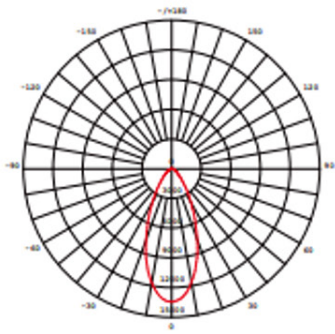

Beam angle: 40°

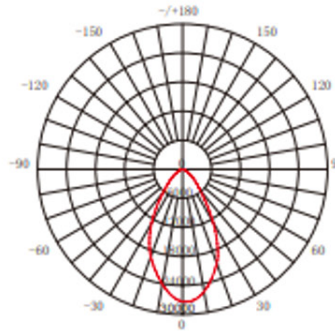

Beam angle: 60°

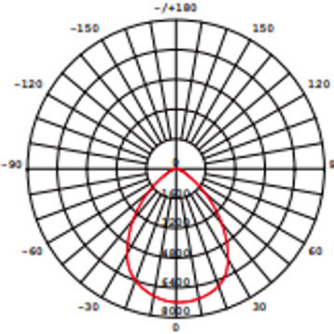

Beam angle: 90°

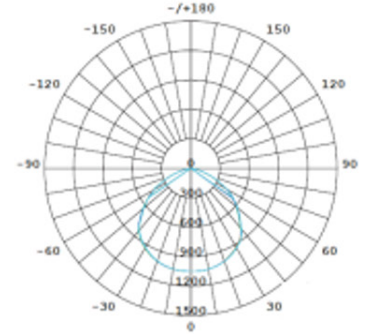

Beam angle: 120°

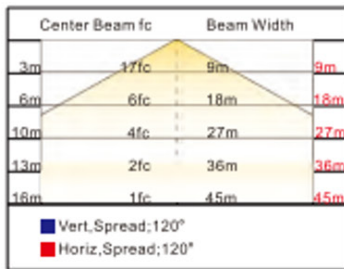

40W/120D

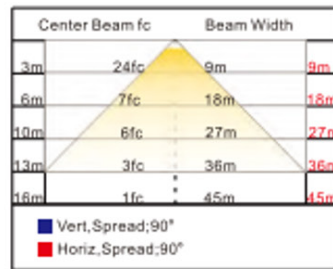

40W/90D

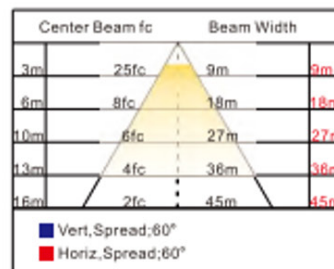

40W/60D

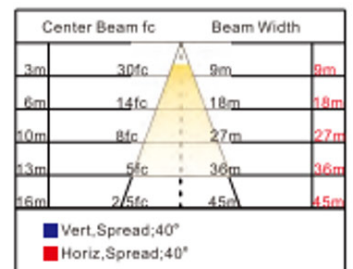

40W/40D

## TECHNICAL DATA

Model	Wattage	Operating Voltage	Total Lumens (Lm)	Efficacy (lm/W)	CRI	CCT
SHI-1	10W	AC 120-277V	1,400	140	>70	2200K-7000K
SHI-2	20W	AC 120-277V	2,800	140	>70	2200K-7000K
SHI-3	30W	AC 120-277V	4,200	140	>70	2200K-7000K
SHI-4	40W	AC 120-277V	5,600	140	>70	2200K-7000K

## DIMENSIONS

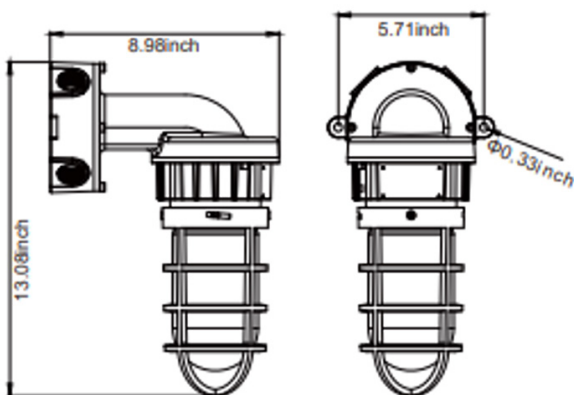

> Please contact our customer service at 920.287.3840 for specific weight and dimensions for mounting accessories and fixture configurations.