



**COMMITTED TO OFFERING AMERICAN INDUSTRY  
A BRIGHTER FUTURE**

LIGHTING CATALOG





# Our Reliability Has Been Proven Under the Harshes Conditions Imaginable

## LEDS MADE FOR THE REAL WORLD — YOUR WORLD.

In theory, LED lighting is supposed to offer significantly improved energy efficiency compared to more traditional commercial and industrial lighting. In reality, environmental factors – including temperature, dust, grit, vibration, moisture and corrosive vapors – can degrade LED performance and reliability rapidly. As a result, American businesses have become increasingly frustrated with all the cheaply designed-and-made products from overseas. You demanded better. We delivered.



## WELCOME TO MILITARY-GRADE LED LIGHTING

Designed and built to a higher standard to deliver the performance, reliability and energy savings you expect from LEDs.

- > Built-In Protection includes seals and gaskets to keep contaminants out
- > Added Reliability and consistency of performance thanks to transient voltage surge suppression
- > Added Durability of best-in-class branded drivers with soldered wires
- > Extended Life due to low LED and driver running temperatures results in the lowest life cycle costs of any industrial-grade LED lighting

## KEEP YOUR COOL WITH REMOTE DRIVERS.

Most Tactik lights utilize remote drivers to prevent unwanted heat build-up inside the fixture, which can degrade performance and is a leading cause of premature fixture failure.



Remote drivers also offer added flexibility, allowing you to easily and economically adjust your lighting to evolving plant floor needs – without costly and time-consuming re-gridding.

## MANAGE MORE EFFECTIVELY WITH SMART TECHNOLOGY.

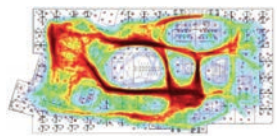

Turn your lighting into smart building solutions with the only U.S. industrial LED lighting manufacturer to offer the world's most advanced wireless lighting control capabilities – Enlighted; A Siemens Company.

- > Improve Workflow using space utilization, motion and occupancy data
- > Optimize Energy Savings with daylight harvesting and task tuning data
- > Increase Productivity of employees and assets with RFID location technology





**Military-Grade Is  
a Matter of Integrity;  
So Is Our Word**

**TACTIK LABS IS YOUR ADDED ASSURANCE OF RELIABILITY**

Our LED lighting is designed to a higher standard. So is our validation process.

At our in-house lab testing facility, our products undergo rigorous testing to provide you every assurance possible that all Tactik LED lighting will perform and last as promised.

While others may talk about performance and reliability in harsh environments, Tactik Labs documents it. Temperature extremes – and even heat build-up. Check. The ability to effectively resist the effects of dust, grit, moisture and corrosive gases. Check.

Because we want to help you make the best-informed

decisions possible regarding your LED lighting choices, we also test leading competitors' units. That way, you can see how our Military-Grade LED Lighting stacks up against the competition in side-by-side comparisons.

Through thousands of installations over 10 years in business, and through years of testing, including 3rd party UL and DLC testing, we've learned a lot. And we look forward to sharing what we've learned with you. After all, the integrity of your LED lighting and the company that manufactures it matters. You have our word on it.

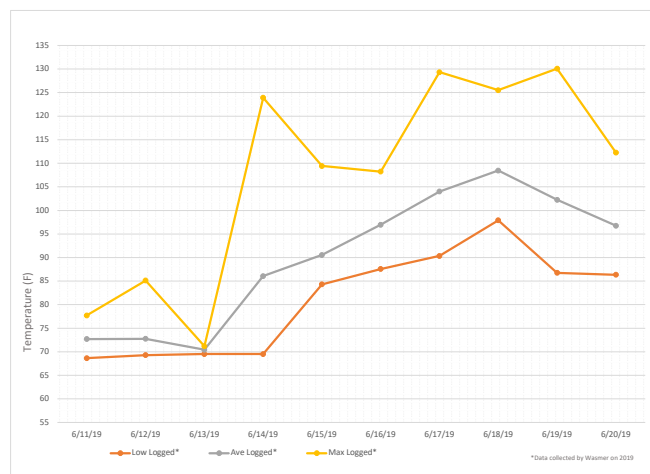

EXTREME TEMPERATURE TESTING



CORROSIVE TESTING AND MORE

**VETERAN OWNED COMPANY  
DEDICATED TO PRODUCTS THAT ARE  
PAPER/TISSUE MILL GRADE TOUGH**

Tactik Lighting CEO and Lead Energy Expert Tim Wasmer, a U.S. Army veteran, makes sure that our “failure is not an option” mindset permeates the entire company. We are far more than just LED lighting engineers. We’re passionately committed to being the team our clients depend on for the right energy efficiency solutions for their businesses. On time. Within budget. Delivering results as promised.

**HOW DO OUR PRODUCTS HOLD UP?**

The team at Tactik Lighting put our military-grade light fixtures to the test. They held up - under the weight of a 5800 lb jeep! That is the strength and durability you can expect from all of the products manufactured and sold by Tactik Lighting.





## Proud to Be the First to Offer American-Made Industrial LEDs



### INTRODUCING LED LIGHTING MADE IN AMERICA'S HEARTLAND

Our latest generation of Paper/Tissue-Grade LED lighting includes fixtures made right here in America. Now, you can get American made quality and craftsmanship that you can see and feel. What you won't see is import tariffs tacked onto your fixture price tag.

### PATENT-PENDING DESIGNS REDEFINE HEAT DISSIPATION

Our NCO and Citadel Series feature an innovative, vertical exterior heat transfer cooling fin to dissipate heat while preventing dust and debris build-up. In addition, internal heat transfer cooling fins are protected against dust and debris build-up for improved cooling efficiency over the life of the fixture. These designs look different because they are different.

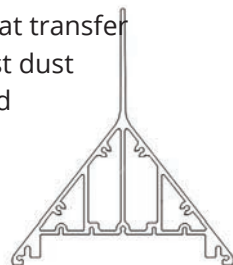

### HIGHER HEAT RATINGS MEAN LONGER LIFE

Our high-heat rated units now feature up to a 30% increase in heat threshold compared to our leading competitors.

What's more, unlike our competitors that experience up to a 45% fall-off in lumen output as they reach their high-heat rating, our fixtures have no such fall-off.

245° F

195° F

125° F

### FAST 2-3 WEEK LEAD TIMES

Leading-edge, modular design and advanced manufacturing capabilities allow us to ship orders, even custom orders- in less time.

And all our products are backed by industry-leading warranties for added peace of mind.



Put it all together and you start to see the real value of lighting made in America specifically for American business.

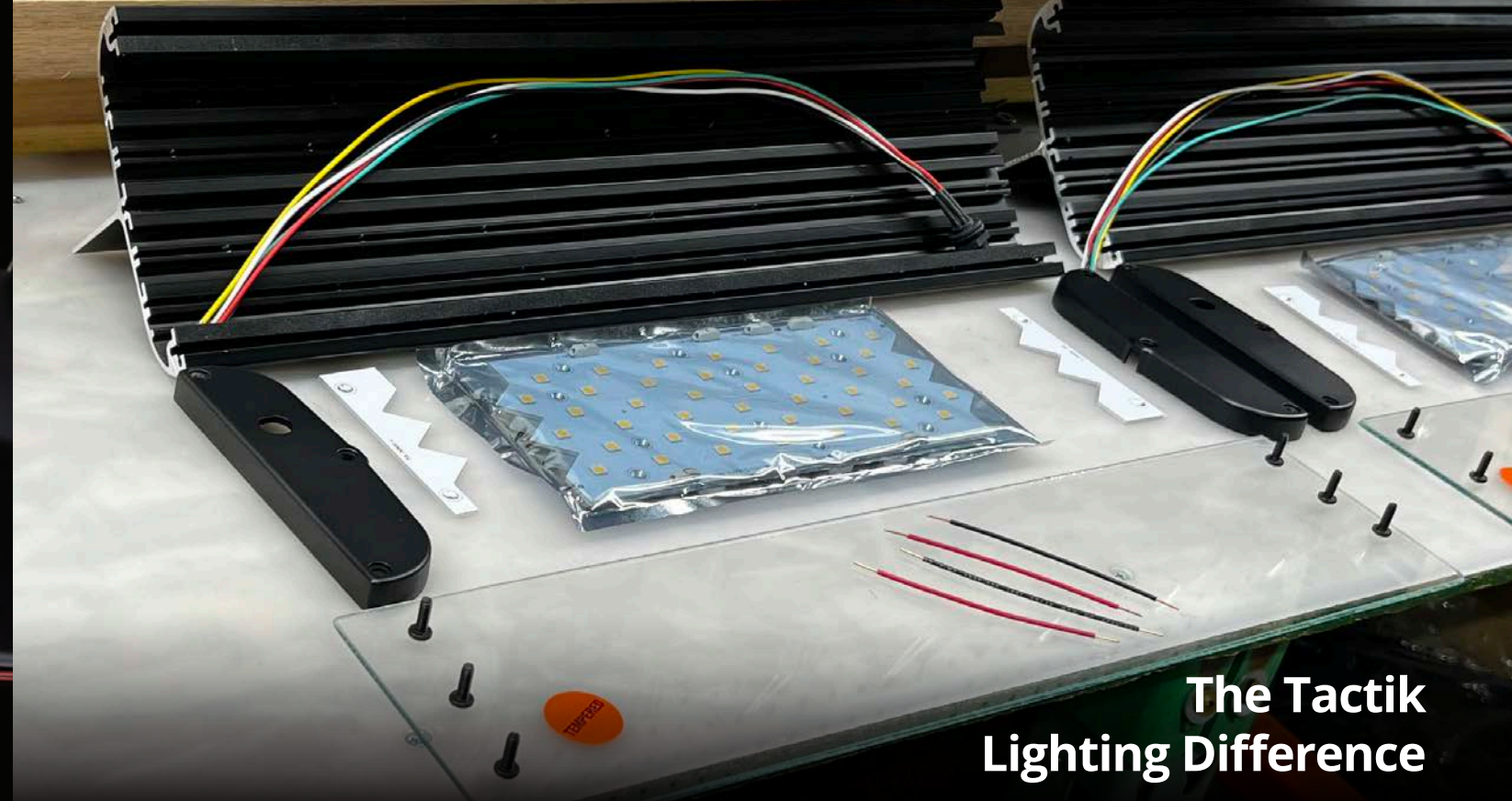

## The Tactik Lighting Difference

### TACTIK LIGHTING'S "BUY IT ONCE" NO OBSOLESCENCE PHILOSOPHY

At Tactik Lighting we believe in continuous innovation and market disruption. One innovative initiative is our "Buy it Once" philosophy. With Tactik's Refurbishment program, any product out of warranty and at the end of its expected life can be returned to the factory for reconditioning.



Our products are designed and built to last long after our competitors products have failed, but eventually they will need to be replaced. If you have ever been in a situation where a few fixtures have failed, only to find they have been discontinued or redesigned so that replacements will not match the existing array, this can be incredibly frustrating. With Tactik Lighting products, that frustration will be a thing of the past.

Tactik's Refurbishment program includes new wearable parts such as LED boards, drivers and transient voltage suppressors. Non wearable parts, such as housings and mounting are reconditioned and a virtually new and updated product is returned, at a much lower price, and with a full 10 year warranty. They will also match your existing fixtures.

No one knows what advancements will be made in LED technology 10 years from now. But our non obsolescence policy promises to maintain state of the art technology, in the same form factor, while promoting sustainability.





# Foot Candle & Optics Representation

## Footcandle Averages 20'x20' grid 120 degree

Lumens									
50000	124	113	107	101	96	91	86	82	77
45000	112	102	96	91	86	82	78	74	70
40000	99	91	84	81	77	73	69	65	62
35000	87	79	75	71	67	64	60	57	54
30000	75	68	64	61	57	55	52	49	46
25000	62	57	53	50	48	46	43	41	39
20000	50	45	43	40	38	36	34	33	31
15000	37	34	32	30	29	27	26	25	23
10000	25	23	21	20	19	18	17	16	15
5000	13	11	11	10	10	9	9	8	8
Height	10'	15'	20'	25'	30'	35'	40'	45'	50'

## Footcandle Averages 25'x25' grid 120 degree

Lumens									
50000	124	75	70	65	62	58	55	53	50
45000	76	67	63	59	55	52	50	47	45
40000	68	60	56	52	49	47	44	42	40
35000	59	53	49	46	43	41	39	37	35
30000	51	45	42	39	37	35	33	32	30
25000	42	38	35	33	31	29	28	26	25
20000	34	30	28	26	25	23	22	21	20
15000	25	23	21	20	18	18	17	16	15
10000	17	15	14	13	12	12	11	11	10
5000	8	8	7	7	6	6	6	5	5
Height	10'	15'	20'	25'	30'	35'	40'	45'	50'

## Footcandle Averages 25'x25' grid 60 degree

Lumens									
50000	89	84	77	72	69	67	65	62	60
45000	81	76	69	65	62	60	59	56	54
40000	72	67	61	58	56	54	52	50	48
35000	63	59	54	51	49	47	45	44	42
30000	54	50	46	43	42	40	39	37	36
25000	45	42	38	36	35	33	32	31	30
20000	36	34	31	29	28	27	26	25	24
15000	27	25	23	22	21	20	19	19	18
10000	18	17	15	14	14	13	13	12	12
5000	9	8	8	7	7	7	6	6	6
Height	10'	15'	20'	25'	30'	35'	40'	45'	50'

### NO OPTICS

> Ideal for general illumination, maximizing horizontal light, and achieving uniform lighting for spaces 30 feet and below.

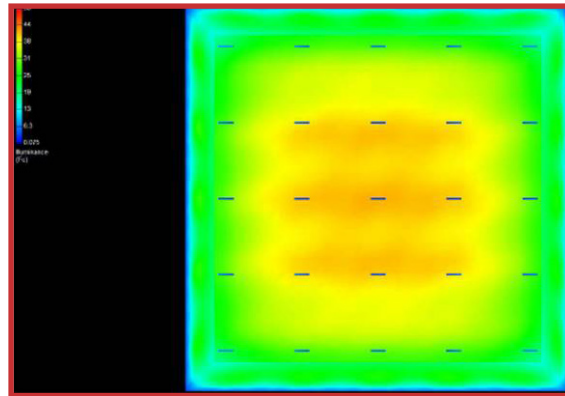

### 60 DEGREE OPTICS

> Great for higher ceilings. Best used for fixtures mounted 30+ feet up. (This image captures a 25 foot mounting height).

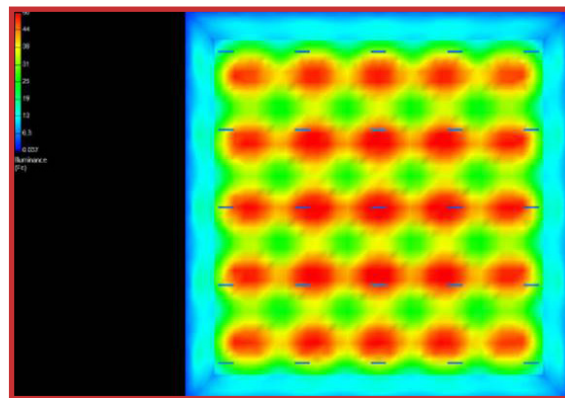

### AISLE OPTICS

> Perfect for racking, Aisle Optics direct light precisely, reducing the number of fixtures or wattage needed when switching to LED.

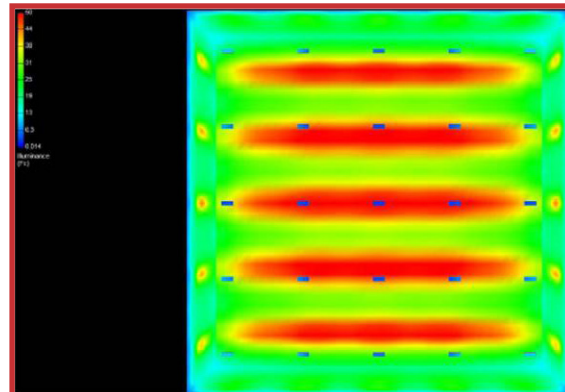

# Motion Sensor Ordering Information

## Wattstopper Low Voltage High/Low/Off PIR Fixture Integrated Outdoor Photo/Motion Sensor (Standard Ordering Selection)



fig 1.1 \*



fig 1.2 \*



### DESCRIPTION

> The standard Wattstopper Motion Sensor mounts in an outdoor lighting fixture and provides multi-level control based on motion and/or daylight contribution. It controls 0-10 VDC dim-to-off LED drivers or ballasts, or works with a power pack to control other loads. When used with an FSP-Lx Lens, the sensor is rated for wet and cold locations. All control parameters are adjustable via a wireless configuration tool capable of storing and transmitting sensor profiles.

### FEATURES

- > Controls 0-10V dim-to-off LED drivers or ballasts, or works with a power pack to control other loads
- > IP66 rated with choice of lenses for wet and outdoor locations, and mounting heights from 8' to 40'
- > Configuration tool stores six sensor profiles for quick setup and adjustment of multiple sensors
- > Polycarbonate construction; flame retardant, UV resistant, impact resistant, recyclable

## Enlighted Ruggedized IoT Motion Sensor (Premium Ordering Selection)

### DESCRIPTION

> The Ruggedized Sensor, 8-pin, is a complete sensing and lighting control node powered from its attached light fixture. Sensor information combined with a configurable behavior profile make the sensor an integral component of an intelligent lighting control and sensing solution. With integrated wireless communications for data transmission and remote configuration along with autonomous fixture-level control, this sensor brings advanced lighting automation to a whole new level.



fig 1.3 \*



### FEATURES

- > Enlighted Sensor Interface (ESI): IoT Ready™ LED drivers and Enlighted Control Units communicate with the sensor via a serial interfaces providing access to energy consumption, and digital lighting control.
- > Localized Lighting Control: Light-level schedules, preferences, and behavior profiles for each fixture are wirelessly communicated during system setup and locally stored to ensure continuous operation.
- > Edge Sensing: Local processing capability supports advanced sensing and detection algorithms, providing optimization of existing features and enabling future applications.
- > Bluetooth Low Energy: An embedded BLE radio allows the sensor to receive, transmit beacons and support communication with lighting control devices and other sensors.
- > Occupancy and Thermal Sensing: A digital Passive Infrared (PIR) sensor, combined with separate ambient and temperature sensing, supports precise motion identification while minimizing false detection events.
- > Room and Zone Control: Pairs with room control switches for code-compliant manual-on or auto-off capability. Sensors can be grouped into zones that share occupancy sensing data and coordinate light control based on detected motion.
- > Two lens options are offered to cover standard (<18 ft.) and high-bay (up to 50 ft.) ceilings.

# Citadel, NCO & Turret - Power Cords

## FEATURES

- > Choose a whip, straight blade or twist lock cord
- > Hardwire or Plug and Play connection to the fixture
- > Lengths- 6ft or 12 ft; contact us for a custom length

## STANDARD POWER CORD OPTIONS (RATED UP TO 158°F)

SERIES	FIXTURE DISCONNECT	VOLTAGE	PLUG AMP RATING	PLUG ATTACHMENT TYPE	LENGTH
PC - Power Cord	HW - Factory Installed Hardwire Cord PP - Plug N Play Connector	125 - 120V 250 - 250V 277 - 277V 480 - 480V 600 - 600V	15 - 15 Amps 20 - 20 Amps	SB - Straight Blade TL - Twist Lock	6 - 6 Feet 12 - 12 Feet
PC					

## POWER CORD WHIP OPTIONS

SERIES	FIXTURE DISCONNECT	VOLTAGE	WHIP	LENGTH
PC - Power Cord	HW - Factory Installed Hardwire Cord PP - Plug N Play Connector	300 - 300V 600 - 600V	W - Whip	6 - 6 Feet 12 - 12 Feet
PC			W	

## EXTREME TEMP POWER CORD OPTIONS (RATED UP TO 392°F)

SERIES	LENGTH	TEMPERATURE
RC	25 - feet in length 50 - feet in length 100 - feet in length 150 - feet in length 200 - feet in length 250 - feet in length 500 - feet in length 1,000 - feet in length	ET
RC		ET

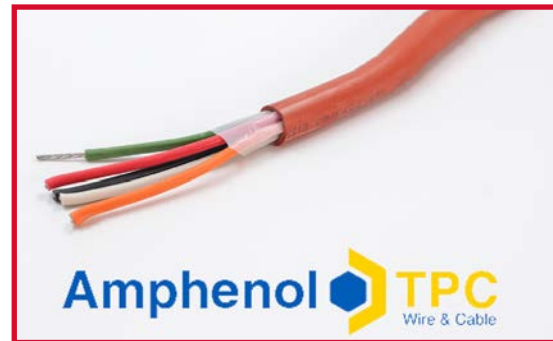

- > twist lock, straight blade, and whip cords, a driver, and a remote cable

# Citadel, NCO & Turret - Accessories

## OUR CABLES VS. OUR COMPETITORS

- > Our Stainless Steel Fixture Safety/Hanging Cables

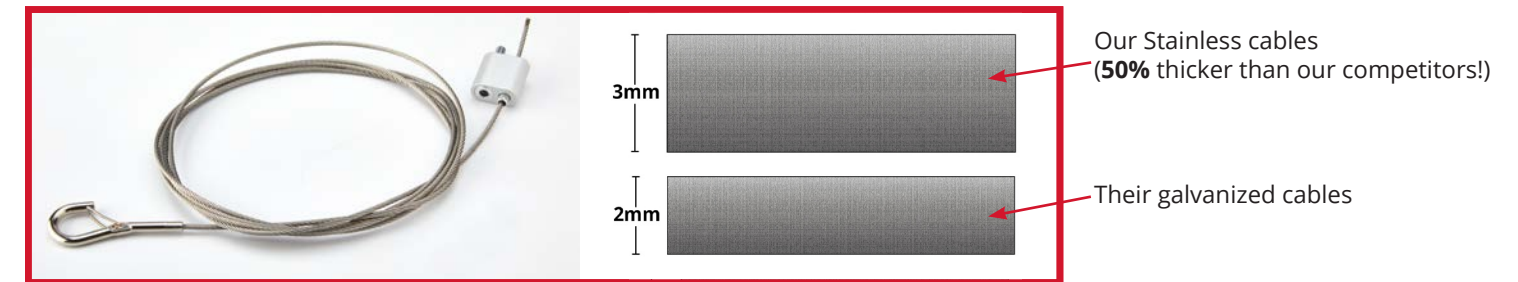

## DRIVERS

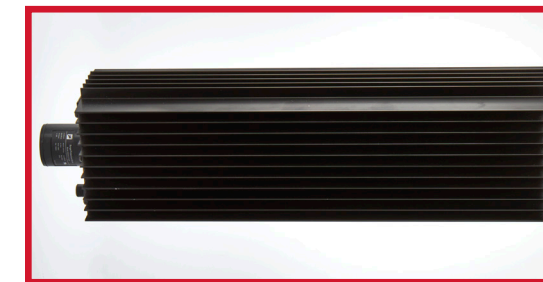

## DRIVER WEIGHT & DIMENSIONS

FIXTURE WATTAGE	WEIGHT	DIMENSIONS
100 Watts	8.090 lbs	Single Driver Box- 19.50" x 4.942" x 3.51" Double Driver Box- 33.50" x 4.942" x 3.51"
150 Watts	8.222 lbs	
200 & 250 Watts	8.720 lbs	
300 Watts	9.140 lbs	
400 & 500 Watts	13.675 lbs	
600 Watts	14.515 lbs	
700 Watts	18.630 lbs	
800 & 900 Watts	19.890 lbs	

## FIXTURE BRACKETS & MOUNTING OPTIONS



**DB-Strut**  
Strut Mount  
Driver Box



**CIT-WM | NCO-WM**  
Universal Swivel  
Mount

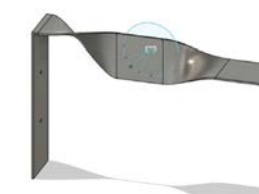

**CIT-WM2 | NCO-WM2**  
Wall  
Mount

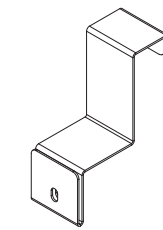

**CIT-PR1 | NCO-PR1**  
Pallet Racking  
Uplight

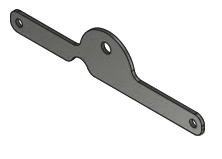

**CIT-HU | NCO-HU**  
Hanging  
Uplight

## ACCESSORIES & MOTION SENSORS



**TUR-APS**  
Prismatic  
Shroud



**FSP-201**  
Wattstopper  
with L7 lens



**FSP-L7**  
Wattstopper  
with L7 lens



**IoT**  
IoT sensor by  
Siemens Enlighted



# Where to Buy | How to Order

REACH OUT TO ONE OF OUR TRUSTED MANUFACTURER'S REPS:

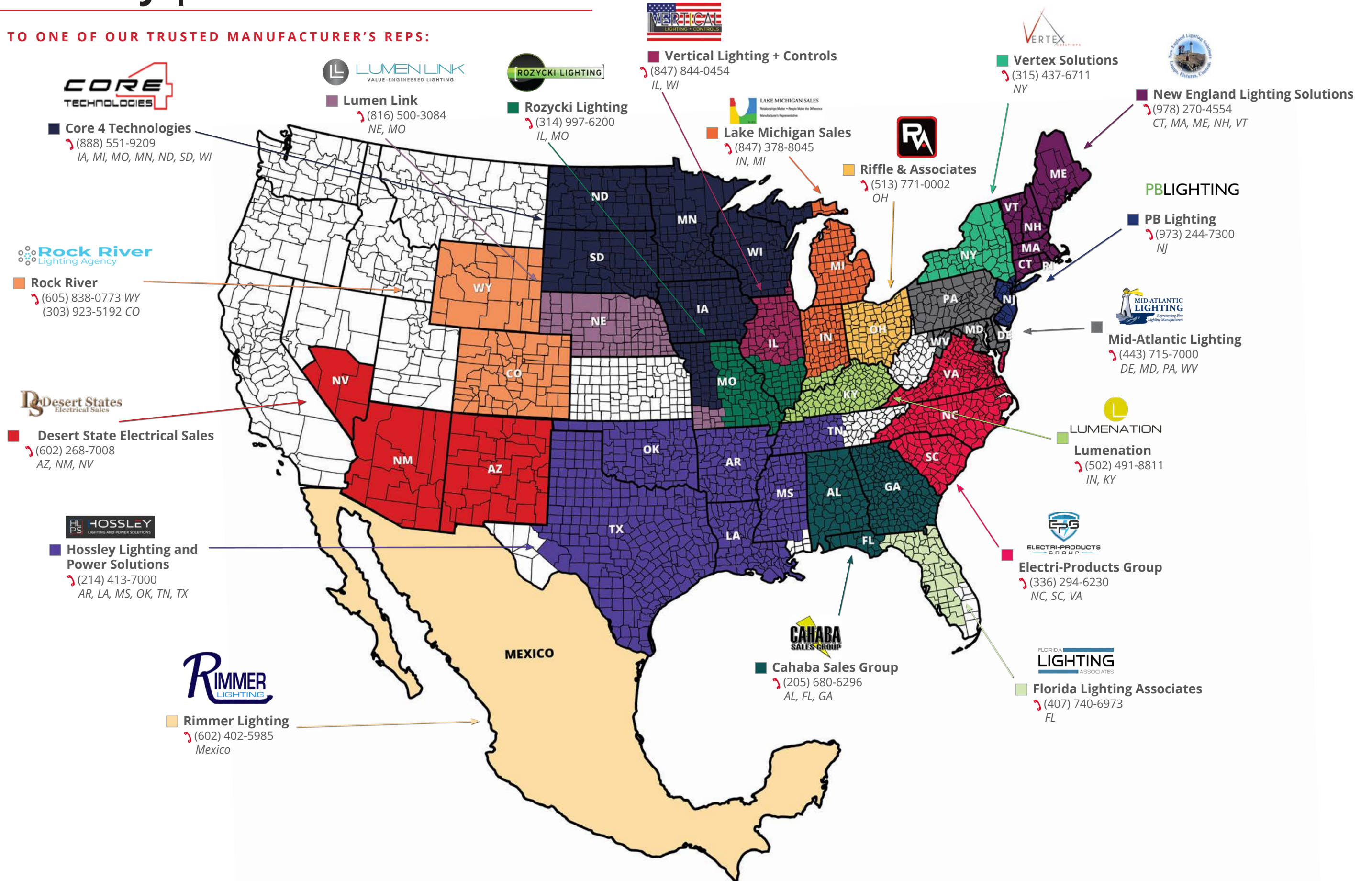

# Distributors

**NAMES:** **TACTIK SUPPLIER NUMBER:**

All-Phase Electric Supply Co.....	
Appalachian Electric .....	TTL100
Border States.....	56876
City Electric Supply.....	
Consolidated Electrical Distributors, Inc. ....	
Cooper Electric .....	499-648
Crescent Electric Supply Company .....	373437
Elliott Electric Supply .....	
Gexpro.....	1052098
Graybar .....	100077509
Green Mountain Electric Supply.....	108726
Kendall Electric.....	
Kirby Risk Electrical Supply .....	
Kovalsky-Carr.....	188794
Low Electric Supply Company .....	
McNaughton-McKay Electric Company.....	100017327
Motion Industries.....	
Rexel .....	1052098
Sonepar .....	35069
Viking Electric.....	21953
Werner Electric Supply .....	9687
Wesco .....	75873
Wholesale Electric Supply .....	
Womack Electric Supply .....	

**FOR MORE INFORMATION:**  
Visit our website [tactiklighting.com/wheretobuy](http://tactiklighting.com/wheretobuy)

# Questions & Contact Information

**FOR QUESTIONS OR FOR MORE INFORMATION:**

By phone: **920-287-3840**  
By e-mail: [sales@tactik.com](mailto:sales@tactik.com)

**OPERATING HOURS:**

8am-4pm central time, Monday through Friday.

**SHIPPING:**

Product is shipped from our facilities in Wisconsin. Purchases of \$4,000 or more are shipped free of charge. All other orders are subject to standard shipping fees.

**PAYMENT TERMS:**

Net 15 days.

**RETURNS:**

Standard products purchased from Tactik Lighting can be returned in the original packaging, unused and in salable condition for a 20% restocking fee. Returns need to be initiated with Tactik Lighting customer service within 45 days of product delivery. Customer is responsible for return shipping costs. Credit will be issued after product has been received and inspected by Tactik Lighting. Custom solutions are not eligible for return.

# Installation Offerings

**YOUR SOLUTION MIGHT REQUIRE MORE THAN LIGHTS ALONE**

If you've got the skilled resources to take on an install, complete instructions are just a download away. Of course, we understand that skilled resources can be hard to come by internally. Should you need help with installation, we're ready and more than willing to help. We can line up trusted installers who are every bit as responsive, thorough, quality-minded and committed to your success as we are.

Our partners also believe in our philosophy that consistency is the key to continuous improvement.

- **Labor pricing** – labor matrix determines labor price.
- **Procedures** – no matter how big or small the project, all are treated the same.
- **Post project documentation** – we will verify that we met or exceeded your goals.





# Citadel Series LED

## Technical Specifications

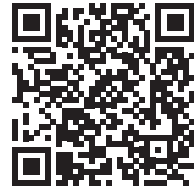

### LUMINOUS OUTPUT, DIMENSIONS & WEIGHT

WATTAGE	OUTPUT	STANDARD TEMP		HIGH TEMP		EXTREME TEMP	
		LENGTH	WEIGHT	LENGTH	WEIGHT	LENGTH	WEIGHT
100 Watts	13,220 lumens	18 in	18.039 lbs	18 in	18.039 lbs	26 in	20.941 lbs
150 Watts	21,600 lumens	18 in	18.171 lbs	26 in	20.941 lbs	34 in	24.209 lbs
200 Watts	28,800 lumens	26 in	21.439 lbs	34 in	24.209 lbs	42 in	26.979 lbs
250 Watts	36,000 lumens	34 in	24.209 lbs	42 in	26.979 lbs	60 in	35.676 lbs
300 Watts	43,200 lumens	34 in	24.629 lbs	50 in	30.169 lbs	68 in	41.844 lbs
400 Watts	57,600 lumens	50 in	34.704 lbs	68 in	41.844 lbs	84 in	42.584 lbs
500 Watts	72,000 lumens	50 in	34.704 lbs	84 in	42.584 lbs	110 in	62.189 lbs
600 Watts	86,400 lumens	68 in	42.684 lbs	102 in	48.964 lbs	126 in	63.135 lbs
700 Watts	100,800 lumens	84 in	47.539 lbs	118 in	58.619 lbs	146 in	70.959 lbs
800 Watts	115,200 lumens	92 in	51.569 lbs	136 in	65.419 lbs	146 in	70.959 lbs
900 Watts	129,600 lumens	102 in	54.339 lbs	146 in	70.959 lbs	146 in	70.959 lbs

### OPERATIONAL TEMPERATURE

STANDARD TEMP	HIGH TEMP	EXTREME TEMP
-40°F to 130°F (or -40°C to 55°C)	-40°F to 195°F (or -40°C to 90°C)	-40°F to 245°F (or -40°C to 118°C)

### CITADEL ORDERING INFORMATION

SERIES	WATTAGE	KELVIN	OPTICS	LENS	FINISH	DRIVER VOLTAGE	REMOTE CABLE	MOTION SENSOR	BATTERY BACKUP	DLC	POWER CORD TYPE	CORD LENGTH
CIT-1 Std Temp	100	40- (4000K)	1- No Optics	2- Flat Poly Clear <sup>2</sup>	1- Black	1- 120/277V	1- 6'	X- No	X- No	X- N/A	1- whip 120-277V	1- 6'
CIT-2 High Temp	150 <sup>1</sup>	50- (5000K)	2- 60°	6- Tempered glass clear		2- 24V DC	2- 10'	1- Standard <sup>3</sup>	1- Yes	1- Standard	2- whip 347-480V	2- 12'
CIT-3 Extreme	200		4- Aisle			4- 347/480V	3- 25'	2- IOT <sup>3</sup>		2- Premium	3- 125V 15amp Straight	4
	250 <sup>1</sup>						4- 50'				4- 125V 20amp Twistlock	5
	300						5- 100'				5- 250V 20amp Twistlock	5
	400 <sup>1</sup>						6- 200'				6- 277V 15amp Twistlock	6
	500 <sup>1</sup>						7- 500'				7- 277V 20amp Twistlock	7
	600 <sup>1</sup>						8- 1,000'				8- 480V 20amp Twistlock	8
	700 <sup>1</sup>						9- Custom				9- 600V 20amp Twistlock	9
	800 <sup>1</sup>										M- M12 3ft	
	900 <sup>1</sup>										M- M12 3ft	

<sup>1</sup> Under review - DLC approval pending

<sup>2</sup> Due to melting concerns, Flat Poly Clear Lenses are only available with CIT-1 Standard Temperature Fixtures

<sup>3</sup> Motion Sensor information: Standard (1) features sensors by Wattstopper with L7 lens. Internet of Things or IOT, (2) features sensors by Enlighted Sensors

### FEATURES

- > Driver temperature up to 167°F (75°C)
- > UL Listed Drivers with less than 1% failure rate
- > Patent-pending remote driver minimizes fixture operating temperature without re-gridding required
- > Patent-pending design extends fixture life by helping prevent build-up of insulating dust and debris and eliminating illumination dead spots
- > Includes 10 Year Module Warranty - Full light engine or plug & play driver module replacement, rather than parts
- > Fail off 15KA transient voltage surge suppressor (TVSS) protects fixture against failure due to power supply surges
- > Optional motion sensor. Choose from standard by Wattstopper with L7 lens (fig 1.1 & fig 1.2\*), or Internet of Things (IOT) by Enlighted Sensors (fig 1.3).
- > Dimmable 0-10V
- > UL 1598 listed
- > IP65 rated

### SPECIFICATIONS

Power Factor.....>0.9  
 Available Wattages.....100, 150, 200, 250, 300, 400, 500, 600, 700, 800, 900  
 Kelvin Temperatures .....4000K, 5000K  
 Input Voltage .....120/277V & 347/480V  
 Performance.....Up to 160 lm/W  
 Distribution.....120°, 60° & Aisle  
 Mount Type.....Suspension  
 Color Rendering Index (4000K) .....>70  
 Color Rendering Index (5000K) .....>90

ORDER NUMBER: CIT-1-100-40-1-2-1-1-1-X-X-X-1-1

### PREVENT PREMATURE FIXTURE FAILURE

As dust & debris accumulate, they act as insulators. This causes internal temperatures to soar and frequently leads to premature fixture failure. The Citadel Series' innovative design addresses this issue three different ways.

1. Patent-Pending Vertical exterior heat transfer cooling fin dissipates heat while preventing dust and debris build-up
2. Steeply sloped sidewalls resist build-up of dust and debris
3. Patent-pending Internal heat transfer cooling fins prevent buildup of dust and debris that can hinder cooling

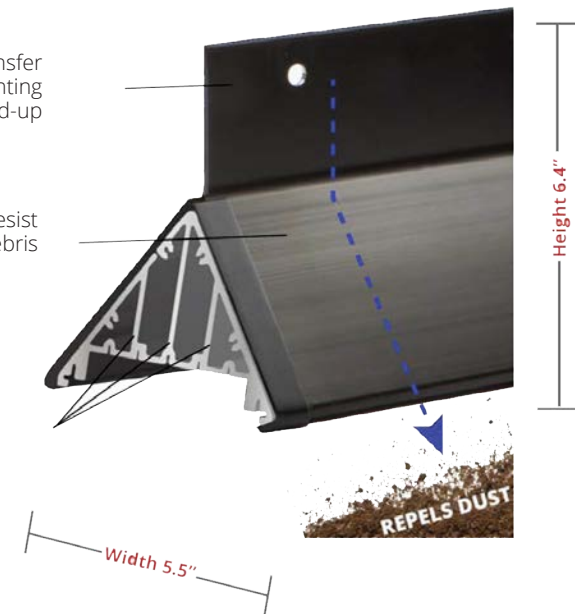

### DAISY CHAIN & CONTROL PANEL OPTIONS

Daisy Chain

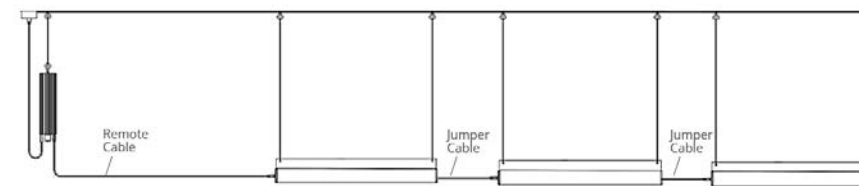

Control Panel for Multiple Lights

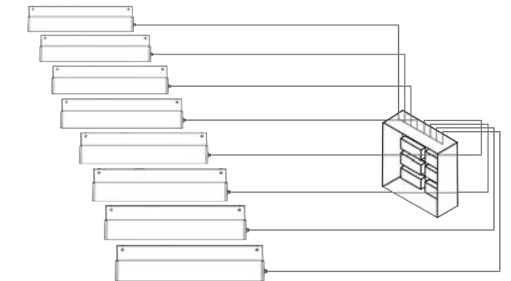

### CITADEL DAISY CHAIN ORDERING INFORMATION

ORDER NUMBER: CIT-1-100-40-1-2-1-1-1-X-X-X-1-1-2-1

SERIES	WATTAGE	KELVIN	OPTICS	LENS	FINISH	DRIVER VOLTAGE	REMOTE CABLE	MOTION SENSOR	BATTERY BACKUP	DLC	POWER CORD TYPE	CORD LENGTH	DAISY CHAIN	FIXTURE CABLE
CIT-1 Std	50	40- (4000K)	1- No Optics	2- Flat Poly Clear <sup>2</sup>	1- Black	1- 120/277V	1- 6'	X- No	X- No	X- N/A	1- whip 120-277V	1- 6'	2	1- 6'
CIT-2 High	100	50- (5000K)	2- 60°	6- Tempered glass clear		2- 24V DC	2- 10'	1- Standard <sup>3</sup>	1- Yes	1- Standard	2- whip 347-480V	2- 12'	3	2- 10'
CIT-3 Extreme	150		4- Aisle			4- 347/480V	3- 25'	2- IOT <sup>3</sup>		2- Premium	3- 125V 15amp Straight	3- 25'	4	3- 25'
							4- 50'				4- 125V 20amp Twistlock	4- 50'	5	4- 50'
							5- 100'				5- 250V 20amp Twistlock	5- 100'		5- 100'
							6- 200'				6- 277V 15amp Twistlock	6- 200'		6- 200'
							7- 500'				7- 277V 20amp Twistlock	7- 500'		7- 500'
							8- 1,000'				8- 480V 20amp Twistlock	8- 1,000'		8- 1,000'
							9- Custom				9- 600V 20amp Twistlock	9- Custom		9- Custom
											M- M12 3ft			

Note:

- 100 Watt Max Daisy Chain = 3.
- 150 Watt Max Daisy Chain = 2.



# NCO Series LED

## Technical Specifications

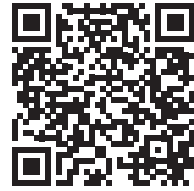

### FEATURES

- > Driver temperature up to 167°F (75°C)
- > UL Listed Drivers with less than 1% failure rate
- > Patent-pending remote driver minimizes fixture operating temperature without re-gridding required
- > Patent-pending design extends fixture life by helping prevent build-up of insulating dust and debris and eliminating illumination dead spots
- > Includes 10 Year Module Warranty - Full light engine or plug & play driver module replacement, rather than parts
- > Fail off 15KA transient voltage surge suppressor (TVSS) protects fixture against failure due to power supply surges
- > Optional motion sensor. Choose from standard by Wattstopper with L7 lens (fig 1.1 & 1.2\*), or Internet of Things (IOT) by Enlighted Sensors (fig 1.3).
- > Dimmable 0-10V
- > UL 1598 listed
- > IP65 rated

### SPECIFICATIONS

Power Factor.....>0.9  
 Available Wattages.....100, 150, 200, 250, 300, 400, 500, 600, 700, 800, 900  
 Kelvin Temperatures .....4000K, 5000K  
 Input Voltage .....120/277V & 347/480V  
 Performance..... Up to 151 lm/W  
 Distribution.....120°, 60° & Aisle  
 Mount Type..... Suspension  
 Color Rendering Index (4000K) .....>70  
 Color Rendering Index (5000K) .....>90

### LUMINOUS OUTPUT, DIMENSIONS & WEIGHT

WATTAGE	OUTPUT	STANDARD TEMP		HIGH TEMP		EXTREME TEMP	
		LENGTH	WEIGHT	LENGTH	WEIGHT	LENGTH	WEIGHT
100 Watts	13,220 lumens	18 in	15.087 lbs	18 in	15.087 lbs	26 in	17.061 lbs
150 Watts	21,600 lumens	18 in	15.219 lbs	26 in	17.061 lbs	34 in	19.401 lbs
200 Watts	28,800 lumens	26 in	17.559 lbs	34 in	19.401 lbs	42 in	21.243 lbs
250 Watts	36,000 lumens	34 in	19.401 lbs	42 in	21.243 lbs	60 in	28.213 lbs
300 Watts	43,200 lumens	34 in	19.821 lbs	50 in	23.505 lbs	68 in	32.994 lbs
400 Watts	57,600 lumens	50 in	28.040 lbs	68 in	32.994 lbs	84 in	32.868 lbs
500 Watts	72,000 lumens	50 in	28.040 lbs	84 in	32.868 lbs	110 in	41.759 lbs
600 Watts	86,400 lumens	68 in	33.834 lbs	102 in	37.392 lbs	126 in	51.989 lbs
700 Watts	100,800 lumens	84 in	37.823 lbs	118 in	45.191 lbs	146 in	53.819 lbs
800 Watts	115,200 lumens	92 in	40.925 lbs	136 in	50.135 lbs	146 in	53.819 lbs
900 Watts	129,600 lumens	102 in	42.767 lbs	146 in	53.819 lbs	146 in	53.819 lbs

### OPERATIONAL TEMPERATURE

STANDARD TEMP	HIGH TEMP	EXTREME TEMP
-40°F to 130°F ( or -40°C to 55°C)	-40°F to 195°F (-40°C to 90°C)	-40°F to 245°F (-40°C to 118°C)

### NCO ORDERING INFORMATION

ORDER NUMBER: NCO-1-100-40-1-2-1-1-1-X-X-X-1-1

SERIES	WATTAGE	KELVIN	OPTICS	LENS	FINISH	DRIVER VOLTAGE	REMOTE CABLE	MOTION SENSOR	BATTERY BACKUP	DLC	POWER CORD TYPE	CORD LENGTH
NCO-1 Std Temp	100	40- (4000K)	1- No Optics	2- Flat Poly Clear <sup>2</sup>	1- Black	1- 120/277V	1- 6'	X- No	X- No	X- N/A	1- whip 120-277V	1- 6'
NCO-2 High Temp	150 <sup>1</sup>	50- (5000K)	2- 60°	6- Tempered glass clear		2- 24V DC	2- 10'	1- Standard <sup>3</sup>	1- Yes	1- Standard	2- whip 347-480V	2- 12'
NCO-3 Extreme	200		4- Aisle			4- 347/480V	3- 25'	2- IOT <sup>3</sup>		2- Premium	3- 125V 15amp Straight	
	250 <sup>1</sup>						4- 50'				4- 125V 20amp Twistlock	
	300						5- 100'				5- 250V 20amp Twistlock	
	400 <sup>1</sup>						6- 200'				6- 277V 15amp Twistlock	
	500 <sup>1</sup>						7- 500'				7- 277V 20amp Twistlock	
	600 <sup>1</sup>						8- 1,000'				8- 480V 20amp Twistlock	
	700 <sup>1</sup>						9- Custom				9- 600V 20amp Twistlock	
	800 <sup>1</sup>										M- M12 3ft	
	900 <sup>1</sup>										M- M12 3ft	

<sup>1</sup> Under review - DLC approval pending

<sup>2</sup> Due to melting concerns, Flat Poly Clear Lenses are only available with NCO-1 Standard Temperature Fixtures

<sup>3</sup> Motion Sensor information: Standard (1) features sensors by Wattstopper with L7 lens. Internet of Things or IOT, (2) features sensors by Enlighted Sensors

### DISSIPATE HEAT MORE EFFICIENTLY

The NCO Series' unique design helps reduce unwanted heat build-up two different ways.

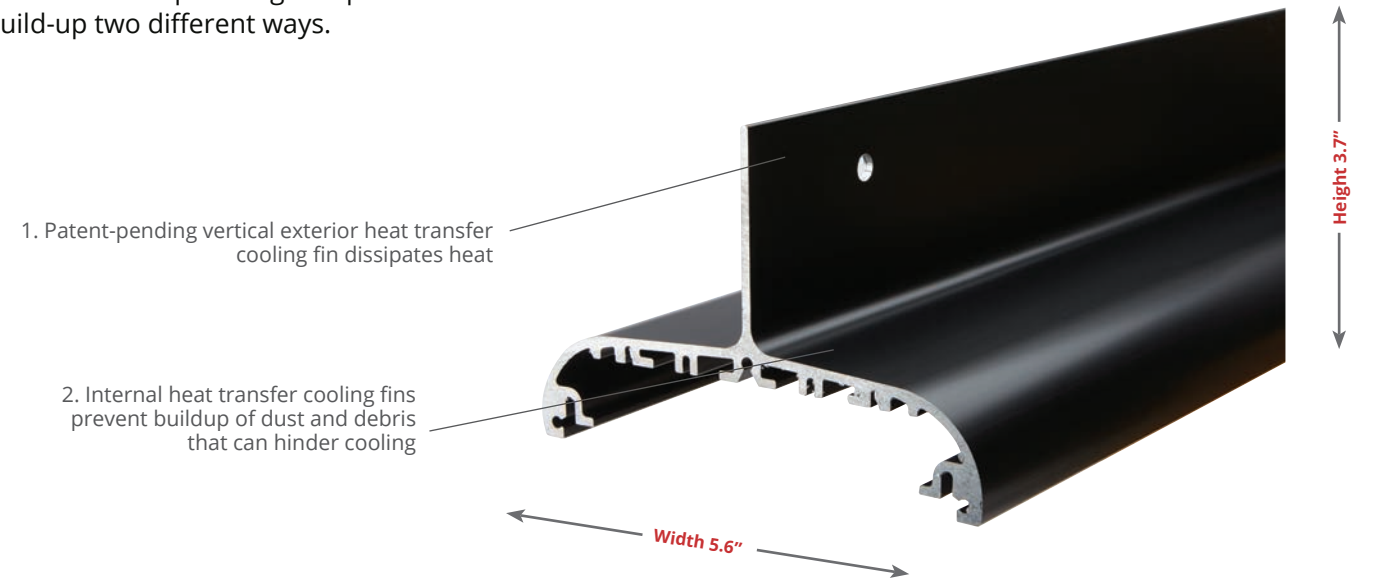

### DAISY CHAIN & CONTROL PANEL OPTIONS

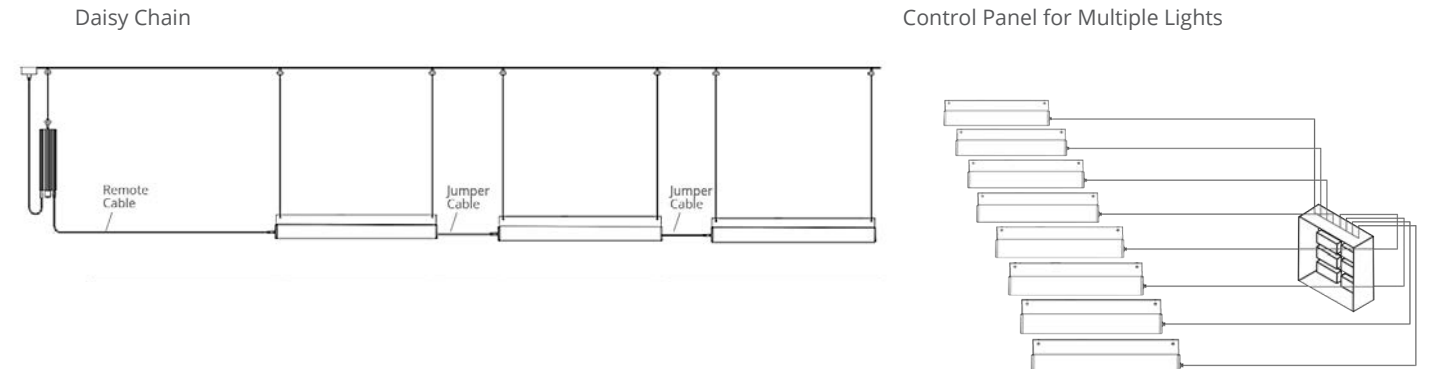

### NCO DAISY CHAIN ORDERING INFORMATION

ORDER NUMBER: NCO-1-100-40-1-2-1-1-1-X-X-X-1-1-2-1

SERIES	WATTAGE	KELVIN	OPTICS	LENS	FINISH	DRIVER VOLTAGE	REMOTE CABLE	MOTION SENSOR	BATTERY BACKUP	DLC	POWER CORD TYPE	CORD LENGTH	DAISY CHAIN	FIXTURE CABLE
NCO-1 Std	50	40- (4000K)	1- No Optics	2- Flat Poly Clear <sup>2</sup>	1- Black	1- 120/277V	1- 6'	X- No	X- No	X- N/A	1- whip 120-277V	1- 6'	2	1- 6'
NCO-2 High	100	50- (5000K)	2- 60°	6- Tempered glass clear		2- 24V DC	2- 10'	1- Standard <sup>3</sup>	1- Yes	1- Standard	2- whip 347-480V	2- 12'	3	2- 10'
NCOxx-3 Extreme	150		4- Aisle			4- 347/480V	3- 25'	2- IOT <sup>3</sup>		2- Premium	3- 125V 15amp Straight		4	3- 25'
							4- 50'				4- 125V 20amp Twistlock		5	4- 50'
							5- 100'				5- 250V 20amp Twistlock			5- 100'
							6- 200'				6- 277V 15amp Twistlock			6- 200'
							7- 500'				7- 277V 20amp Twistlock			7- 500'
							8- 1,000'				8- 480V 20amp Twistlock			8- 1,000'
							9- Custom				9- 600V 20amp Twistlock			9- Custom
											M- M12 3ft			

Note:

100 Watt Max Daisy Chain = 3.

150 Watt Max Daisy Chain = 2.



# Turret Series LED

## Technical Specifications

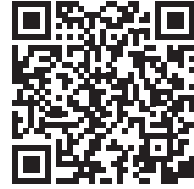

### FEATURES

- > Driver temperature up to 167°F (75°C)
- > UL Listed Drivers with less than 1% failure rate
- > Patent-pending remote driver minimizes fixture operating temperature and allows fixture to evolve with changing plant floor demands with no re-gridding required
- > Includes 10 Year Module Warranty - Full light engine or plug & play driver module replacement, rather than parts
- > Fail off 15KA transient voltage surge suppressor (TVSS) protects fixture against failure due to power supply surges
- > Optional motion sensor. Choose from standard by Wattstopper with L7 lens, or Internet of Things (IOT) by Enlighted Sensors (fig 1.3).
- > Dimmable 0-10V
- > UL 1598 listed
- > IP65 rated

### LUMINOUS OUTPUT & DIMENSIONS

WATTAGE	STANDARD TEMP		HIGH TEMP	
	OUTPUT	DIMENSIONS	OUTPUT	DIMENSIONS
100 Watts	14,400 lm	11" D x 1.9" H	13,940 lm	11" D x 1.9" H
150 Watts	22,180 lm	11" D x 1.9" H	22,180 lm	16" D x 2.2" H
200 Watts	32,730 lm	16" D x 2.2" H	32,730 lm	16" D x 2.2" H
250 Watts	39,910 lm	16" D x 2.2" H	39,910 lm	18" D x 3.5" H
300 Watts	49,550 lm	18" D x 3.5" H	49,550 lm	18" D x 3.5" H
350 Watts	57,973 lm	18" D x 3.5" H	N/A	N/A
400 Watts	66,050 lm	18" D x 3.5" H	N/A	N/A

### OPERATIONAL TEMPERATURE

STANDARD TEMP	HIGH TEMP
-40°F to 125°F (-40°C to 52°C)	-40°F to 185°F (-40°C to 80°C)

### SPECIFICATIONS

Power Factor.....>0.9  
 Available Wattages.....100, 150, 200, 250, 300, 350, 400  
 Kelvin Temperatures ..... 4000K, 5000K  
 Input Voltage ..... 120/277V & 347/480V  
 Performance.....Up to 163 lm/W  
 Distribution.....120°  
 Mount Type.....Suspension  
 Color Rendering Index (4000K) .....>70  
 Color Rendering Index (5000K) .....>90

### TURRET ORDERING INFORMATION

SAMPLE ORDER NUMBER: TUR-1-100-40-1-2-1-1-X-X-X-X-1-1

SERIES	WATTAGE	KELVIN	OPTICS	LENS	FINISH	DRIVER VOLTAGE	REMOTE CABLE	MOTION SENSOR	BATTERY BACKUP	DLC	POWER CORD TYPE	CORD LENGTH
TUR-1 Std Temp	100	40- (4000K)	1- None	2- Flat Poly Clear <sup>3</sup>	1- Black	1- 120/277V	X- Integrated Driver	X- No	X- No	X- N/A	1- whip 120-277V	1- 6'
TUR-2 High Temp	150	50- (5000K)		6- Tempered glass clear		2- 24V DC	0- Top Mount	1- Standard <sup>4</sup>	1- Yes	1- Standard	2- whip 347-480V	2- 12'
	200					4- 347/480V	C- Crane Bay	2- IOT <sup>4</sup>		2- Premium	3- 125V 15amp Straight	
	250										4- 125V 20amp Twistlock	
	300										5- 250V 20amp Twistlock	
	350 <sup>2</sup>										6- 277V 15amp Twistlock	
	400 <sup>1,2</sup>										7- 277V 20amp Twistlock	
											8- 480V 20amp Twistlock	
											9- 600V 20amp Twistlock	
											M- M12, 3ft	
											8- 1,000'	
											9- Custom	

<sup>3</sup> Due to melting concerns, Flat Poly Clear Lenses are only available with TUR-1 Standard Temperature Fixtures

<sup>4</sup> Motion Sensor information: Standard (1) features sensors by Wattstopper with L7 lens. Internet of Things or IOT, (2) features sensors by Enlighted Sensors

### PRODUCT EXAMPLES

#### Top-Mount Driver

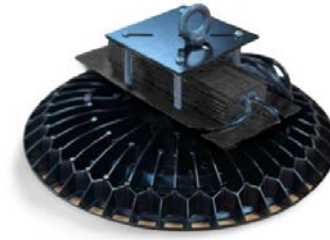

#### Integrated Driver



#### Crane Bay



### DAISY CHAIN & CONTROL PANEL OPTIONS

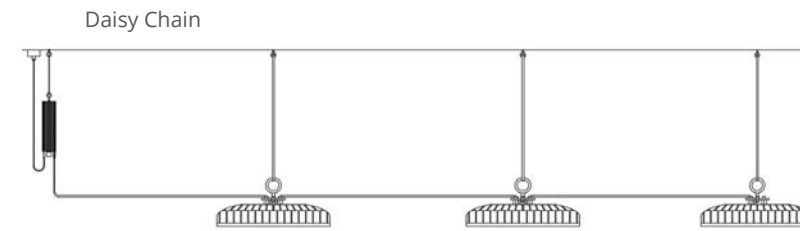

Control Panel for Multiple Lights

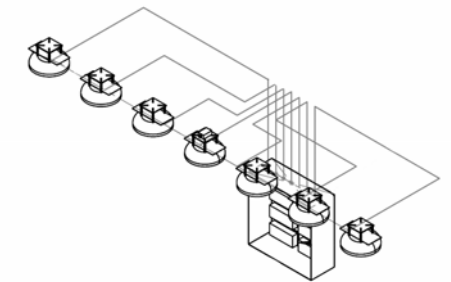

### TURRET DAISY CHAIN ORDERING INFORMATION

ORDER NUMBER: TUR-1-100-40-1-2-1-1-X-X-X-X-1-1-2-1

SERIES	WATTAGE	KELVIN	OPTICS	LENS	FINISH	DRIVER VOLTAGE	REMOTE CABLE	MOTION SENSOR	BATTERY BACKUP	DLC	POWER CORD TYPE	CORD LENGTH	DAISY CHAIN	FIXTURE CABLE
TUR-1 Std	100	40- (4000K)	1- None	2- Flat Poly Clear	1- Black	1- 120/277V	X- Int. Driver	X- No	X- No	X- N/A	1- whip 120-277V	1- 6'	2	1- 6'
TUR-2 High	150	50- (5000K)		6- Tempered glass clear		2- 24V DC	0- Top Mount	1- Standard	1- Yes	1- Standard	2- whip 347-480V	2- 12'	3	2- 10'
						4- 347/480V	C- Crane Bay	2- IOT		2- Premium	3- 125V 15amp Straight			3- 25'
											4- 125V 20amp Twistlock			4- 50'
											5- 250V 20amp Twistlock			5- 100'
											6- 277V 15amp Twistlock			6- 200'
											7- 277V 20amp Twistlock			7- 500'
											8- 480V 20amp Twistlock			8- 1,000'
											9- 600V 20amp Twistlock			9- Custom
											M- M12, 3ft			
											8- 1,000'			
											9- Custom			

Note:  
 100 Watt Max Daisy Chain = 3.  
 150 Watt Max Daisy Chain = 2.



# Garrison Series LED

## Technical Specifications

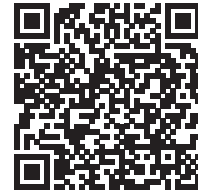

### SPECIFICATIONS

Input Voltage .....	120/277V
Performance.....	Up to 144 lm/W
Distribution.....	120°
Mount Type.....	Suspended or Surface Mounted
Available Wattages.....	50W, 75W, 100W, 125W
Kelvin Temperature .....	4000K, 5000K
Dimensions.....	L51.8" x W7.5" x H4.4"
Color Rendering Index .....	>70

### OPERATIONAL TEMPERATURE

STANDARD TEMP	EXTREME TEMP
-40°F to 149°F (-40°C to 65°C)	-40°F to 200°F (-40°C to 93°C)

### LUMINOUS OUTPUT & DIMENSIONS

WATTAGE	OUTPUT	DIMENSIONS
50 Watts	7,200 lumens	51.8" x 7.5" x 4.4"
75 Watts	10,500 lumens	
100 Watts	14,400 lumens	
125 Watts	16,000 lumens	

### GARRISON ORDERING INFORMATION

SAMPLE ORDER NUMBER: GAR-7-X50-40-1-3-2-1-1-X-X-1

SERIES	WATTAGE	KELVIN	OPTICS	LENS	FINISH	DRIVER VOLTAGE	REMOTE CABLE	MOTION SENSOR	BATTERY BACKUP	CORD
GAR-7 Std	X50- (50W)	40- (4000K)	1- No Optics	3- Drop Poly Frosted	2- Stainless	1- 120/277V	1- N/A	X- No	X- No	1- 125V, 15amp, SB, 6ft
GAR-8 Extreme	X75- (75W)	50- (5000K)				2- 24V DC		1- Standard*	1- Yes	3- 125V, 15amp, TL, 6ft
	100- (100W)							2- Internet of Things*		9- 277V, 15amp, TL, 6ft
	125- (125W)									D- 300V, Whip, 6ft
										M- M12, 3ft

\* Motion Sensor part information: Standard (1) features sensors by Wattstopper with L7 Lens. Internet of Things (2) features sensors by Enlighted Sensors

### FEATURES

- > Stainless housing for optimal heat dissipation
- > Suspend or surface mount the fixture
- > In-series transient voltage surge suppressor (TVSS) protects fixture against failure due to dirty power and power supply surges
- > Dimmable 0-10V
- > Optional motion sensor to maximize energy efficiency. Choose from standard by Wattstopper with L7 lens (fig 1.1 & 1.2\*), or Internet of Things (IOT) by Enlighted Sensors (fig 1.3).
- > Includes 5 Year Parts Warranty
- > UL 1598 listed
- > Rated IP65

### OPTIONAL ACCESSORIES

- > Motion Sensor
- > 10' Aircraft Cable Kit
- > Emergency Battery Backup (see page 2 for more information)

### ADDITIONAL DATA

- > Stainless Steel Type: SS-304
- > Remote Cable(s): Up to 90°C (194°F)
- > Polycarbonate Lens: Up to 138°C (280°F)
- > Motion Sensor: Up to 77°C (167°F)
- > UL 1598 listed
- > Rated IP65

# APACHE Series LED

## Technical Specifications

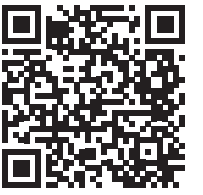

### APPLICATIONS

- > Power Plants / Heavy Industrials
- > Distillery, Alcohol
- > Paper Mills / Wastewater Treatment Plants
- > Loading Docks / Platforms / Shipyards
- > Chemical Processing Facility
- > Mining
- > Ocean Marine
- > LNG facilities
- > Metal Industry
- > Meanwell Driver

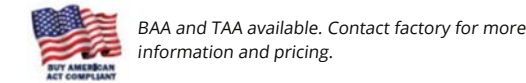

### LUMINOUS OUTPUT & DIMENSIONS

WATTAGE	3000K	4000K	5000K	6000K	DIMENSIONS
20 Watts	2,000 lumens	2,560 lumens	2,700 lumens	2,800 lumens	2 foot - 23.3" x 9.1" x 5.5"
30 Watts	3,600 lumens	3,840 lumens	4,050 lumens	4,200 lumens	
40 Watts	4,800 lumens	5,120 lumens	5,400 lumens	5,600 lumens	4 foot - 46.6" x 9.1" x 5.5"
50 Watts	6,000 lumens	6,400 lumens	6,750 lumens	7,000 lumens	
60 Watts	7,200 lumens	7,680 lumens	8,100 lumens	8,400 lumens	
80 Watts	9,600 lumens	10,240 lumens	10,800 lumens	11,200 lumens	
100 Watts	12,000 lumens	12,800 lumens	13,500 lumens	14,000 lumens	
120 Watts	14,400 lumens	15,360 lumens	16,200 lumens	16,800 lumens	

### APACHE ORDERING INFORMATION

SAMPLE ORDER NUMBER: APA-4-1-8-1-3-1-1-2-X

SERIES	LENGTH	LENS	WATTAGE	VOLTAGE	CCT	OPTIC	DRIVER	WARRANTY	OPTIONS
APA	2- 2 feet	1- Glass	2- 20W	1- AC 120-277V	1- 3000K	1- 120°	1- Dim	5- 5 Year	X- None
	4- 4 feet		3- 30W	2- AC 277-480V	2- 4000K		2- Non-Dim	10- 10 Year	1- EMB
			4- 40W	3- DC 12-36V	3- 5000K				2- Custom Cable Length
			5- 50W		4- 6000K				3- Junction Box
			6- 60W						4- BAC*
			8- 80W						5- TAC*
			10- 100W						
			12- 120W						

\* BAC = Buy American Compliant | TAC\* = Trade Agreements Act Compliant



# BRIGADIER Series LED

## Technical Specifications

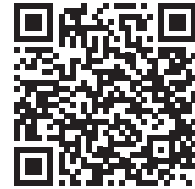

### FEATURES

- > Available in 30W, 50W, 75W, 100W, 120W; 150W, 180W, 200W, 240W
- > Optional stainless steel guard
- > Wildlife Friendly for coastal areas.
- > 1-10V dimmable and DALI control optional.
- > IP66 and IK08 double protection, with super reliability
- > Input Voltage: AC120-277V, AC277-480V (50/60Hz)
- > Pendant, Ceiling, Wall, Trunnion, 25° Stanchion and 90° Stanchion mounting options
- > Warm White-Cool White options 2000K - 6500K
- > Colored LED available: R/G/B/AMBER options
- > Type I, III and V light distribution options
- > The max operating ambient temperature range: -40°C to 65°C
  - 50/75/100W: -40° to +60°
  - 30/120W: -40° to +65°
  - 150W: -40° to +55°
  - 180/200/240W: -40° to +45°
- > Flip-type structure for easy access to internal components provides up to 1,350lm illumination for 90 minutes of emergency lighting
- > Well-organized terminal block, the ceiling mounting, bracket mounting and wall mounting are equipped with four conduit holes.
- > Easy wiring with self-locking spring terminals.
- > Equipped with low copper aluminum alloy body and special powder coating, as well as stainless steel components with special anti-corrosion treatment make it suitable for marine environments for over 10 years.
- > LED chips are separated from the driver cavity, ensures good heat dissipation and longer service life.

### CERTIFICATIONS AND LISTINGS UL:

- > Class I, Division 2, Groups A, B, C, D
- > Class II, Division 1, Groups E, F, G
- > Class II, Division 2, Groups F, G
- > Class III
- > NEMA 4X
- > UL 1598 - Wet Locations || UL 1598A - Marine || UL 8750 - LED Safety || UL 844 - Hazardous Locations CSA Standard || UL924 - Emergency Lighting
- > CSA C22.2 No. 137
- > CSA C22.2 No. 250.0
- > CSA C22.2 No. 141

### APPLICATIONS

- > Power Plants
- > Heavy Industrials Storage Facility
- > Paper Mills
- > Wastewater Treatment Plants
- > Loading Docks
- > Platforms
- > Shipyards
- > Chemical Processing Facility
- > Petrochemical Processing Facility

### LUMINOUS OUTPUT

WATTAGE (W)	30W	50W	75W	100W	120W	150W	180W	200W	240W
LUMENS (Lm)	4,050 Lm	6,750 Lm	10,125 Lm	13,500 Lm	16,200 Lm	20,250 Lm	24,300 Lm	27,000 Lm	32,400 Lm

### BRIGADIER ORDERING INFORMATION

SAMPLE ORDER NUMBER: BRI-20-1-3-T32003-2-X-2-5

SERIES	WATTAGE	VOLTAGE	CCT	OPTICAL	CRI	ACCESSORIES	MOUNTING	WARRANTY
BRI	3- 30W	1- 120-277V	1- 3000K	See Photometrics Codes Spec Sheet via QR Code	1- 70	X- None	1- Trunnion Mount	5- 5 Year
	5- 50W	2- 277-480V	2- 4000K		2- 80	1- 3/4" NPT	2- Ceiling Mount	10- 10 Year
	7- 75W		3- 5000K		3- 90	2S- Wire Guard 30-100W	3- Pendant Mount	
	10- 100W		R- Red			2L- Wire Guard 120-240W	4- Wall Mount	
	12- 120W		G- Green				5- 25° Stanchion Mount	
	15- 150W		B- Blue				6- 90° Stanchion Mount	
	18- 180W		A- Amber					
	20- 200W							
	24- 240W							

# COLONEL Series LED

## Technical Specifications

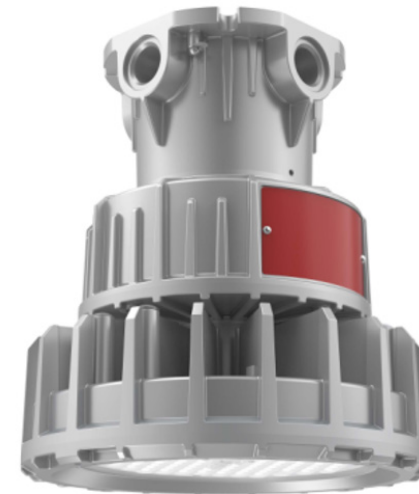

### FEATURES

- > Standard 120° Optic
- > Wildlife Friendly for coastal areas.
- > Available in 30W, 40W, 50W, 60W, 70W;
- > 1-10V dimmable and DALI control optional.
- > IP66 and IK10 double protection, with super reliability
- > Input Voltage: AC120-277V, AC277-480V (50/60Hz)
- > Pendant, Ceiling, Wall, Trunnion, 25° Stanchion
- > Warm White-Cool White options 2000K - 6500K
- > Colored LED available: R/G/B/AMBER options
- > The max operating ambient temperature range: -40°C to 65°C (-40°F to +149°F).
- > Quick connection design, the installation wiring module is connected with the fixture thread, more convenient and faster installation and wiring.
- > Equipped with low copper aluminum alloy body and special powder coating, as well as stainless steel components with special anti-corrosion treatment.
- > Well-organized terminal block, the ceiling mounting, bracket mounting and wall mounting are equipped with four conduit holes.
- > LED chips are separated from the driver cavity, ensures good heat dissipation and longer service life.
- > Optional stainless-steel guard

### APPLICATIONS

- > Chemical
- > Oil, gas and petrochemical
- > Pulp and paper
- > Foundries
- > Manufacturing
- > Waste and sewage treatment
- > Power generation
- > Paint spray booths

### LUMINOUS OUTPUT

LUMINOUS OUTPUT	4200-9800 Lumens
EFFICACY (Lm/W)	Up to 140 Lm/W

### CERTIFICATIONS AND LISTINGS UL:

- > Class I, Division 1, Groups B, C, D
- > Class I, Division 2, Groups A, B, C, D
- > Class II, Division 1, Groups E, F, G
- > Class II, Division 2, Groups F, G
- > Class III
- > NEMA 4X
- > UL 1598 - Wet Locations | UL 1598A - Marine | UL 8750 - LED Safety | UL 844 - Hazardous Locations

### CSA Standard

- > CSA C22.2 No. 137
- > CSA C22.2 No. 250.0

### PRODUCT MOUNTING DIMENSIONS

Unit	Ceiling Mount			25° Stanchion Mount				Wall Mount				Pendant Mount			Trunnion Mount			
	A	B	C	A	B	C	D	A	B	C	D	A	B	C	A	B	C	D
Inch	10.8"	7.0"	9.8"	10.8	7.0	9.8	12.6	10.7	7.0	9.8	13.2	11.5	7.0	9.8	13.7	11.5	11.2	9.1
mm	274	179	248	275	179	248	320	271	179	248	336	292	179	248	348	292	284	230

### COLONEL ORDERING INFORMATION

SAMPLE ORDER NUMBER: COL-5-1-2-1-3-X-2-5

SERIES	WATTAGE	VOLTAGE	CCT	OPTICAL	CRI	ACCESSORIES	MOUNTING	WARRANTY
COL	3- 30W	1- 120-277V	1- 3000K	1- 120°	1- 70	X- None	1- Trunnion Mount	5- 5 Year
	4- 40W	2- 277-480V	2- 4000K		2- 80	1- 3/4" NPT	2- Ceiling Mount	10- 10 Year
	5- 50W		3- 5000K		3- 90	2- Wire Guard	3- Pendant Mount	
	6- 60W		R- Red				4- Wall Mount	
	7- 70W		G- Green				5- 25° Stanchion Mount	
			B- Blue					
			A- Amber					



# SHERMAN Series LED

## Technical Specifications

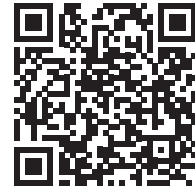

### FEATURES

- > Expected Life: 50,000 hours
- > Rating: UL844 Class 1 Division 2
- > Color Rendering Index (CRI): >70
- > Operating Temp: -40°C to +45°C
- > Power Factor: >0.9
- > Input Line Voltage:
  - 100-277V
  - 200-480V
- > Input Line Frequency: 50/60Hz
- > LED Chips: Philips
- > Driver: Meanwell
- > Housing: Standard 304 Stainless Steel
  - Optional 316 Stainless Steel
- > Hardware: 304 Stainless Steel
- > Lens: Polycarbonate

### COMPLIANCE

#### UL 844 Hazardous Locations North America

- > Class I, Division 2, Groups A, B, C, D
- > Class II, Division 1, Groups E, F, G
- > Class II, Division 2, Groups F, G
- > Class III

#### Marking Atex

- > II 2 G Ex db eb mb IIC T5/T6 Gb
- > II 2 D Ex tb IIIC T95°C/T85°C Db IP66

#### Marking ICEX

- > Ex db eb mb IIC T5/T6 Gb
- > Ex tb IIIC T95°C/T85°C Db

#### Marking Marine

- > UL1598, UL1598A

#### Other Markings/Standards

- > IP66



BAA and TAA available. Contact factory for more information and pricing.

### APPLICATIONS

- > Power Plants / Heavy Industrials
- > Distillery, Alcohol
- > Paper Mills / Wastewater Treatment Plants
- > Loading Docks / Platforms / Shipyards
- > Chemical Processing Facility
- > Mining
- > Ocean Marine
- > LNG facilities
- > Metal Industry

### LUMINOUS OUTPUT & DIMENSIONS

WATTAGE	OUTPUT	DIMENSIONS
20 Watts	2,800 lumens	2 foot - 27.48" x 8.66" x 5.45"
30 Watts	4,200 lumens	
40 Watts	5,600 lumens	4 foot - 51.97" x 8.66" x 5.45"
50 Watts	7,000 lumens	
60 Watts	8,400 lumens	

### SHERMAN ORDERING INFORMATION

SAMPLE ORDER NUMBER: SHE-2-4-1-2-1-1-2-2-5

SERIES	LENGTH	WATTAGE	VOLTAGE	CCT	OPTIC	DRIVER	OPTIONS	MOUNTING/ACCESSORIES	WARRANTY
SHE	2- 2 feet	2- 20W	1- 120-277V	1- 4000K	1- 120°	1- 0-10V Dim	1- Sensor	1- Pendant Mount	5- 5 Year
	4- 4 feet	3- 30W	2- 277-480V	2- 5000K		2- Non-Dim	2- 316 Stainless Steel Hardware	2- Surface Mount	10- 10 Year
		4- 40W					3- BAA	3- Wall Mount	
		5- 50W					4- TAA	4- Pole Mount	
		6- 60W							

# SHIELD Series LED

## Technical Specifications

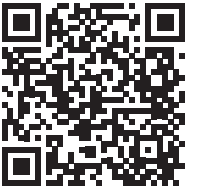

### FEATURES

- > Lens: Tempered Glass
- > LED Chips: Philips
- > Driver: Meanwell
- > Hardware: Stainless Steel 304
- > Finish: Polyester Powder coat
- > Surge Protection: 10KV
- > Expected Life: Over 85,000 hrs.
- > Color Rendering Index (CRI): 70
- > Heavy-duty and high impact resistance
- > Four connection cable entry points
- > Dimmable and non-dimmable options available.
- > Emergency battery backup available with integrated junction box for driver.
- > Tempered glass lens standard with opal globe and guard. Options include:
  - Flat Glass Lens
  - Dome Reflector
  - Angle Reflector
- > Standard 120-277V, Available options include:
  - 12-36VDC
- > Operating Temperature: -20°C - 60°C (-4°F - 140°F)
- > Housing: Copper Free A383 Die Cast Aluminum
- > Gasketing: Fluorosilicone Rubber

### APPLICATIONS

- > Power Plants / Heavy Industrials Storage Facility
- > Paper Mills / Wastewater Treatment Plants
- > Loading Docks / Platforms / Shipyards
- > Chemical Processing Facility
- > Petrochemical Processing Facility
- > Mining
- > Ocean Marine
- > LNG facilities
- > Metal Industry
- > Food and distilling
- > Alcohol Industry
- > Steel and aluminum factories

### COMPLIANCE

#### UL 844 Hazardous Locations North America

- > Class I, Division 2, Groups A, B, C, D
- > Class II, Division 1, Groups E, F, G
- > Class II, Division 2, Groups F, G
- > Class III

#### Other Ratings

- > NEMA 4X, IP66, IK10, UL1598A Marine Vessels, UL924 Emergency Lighting



BAA and TAA available. Contact factory for more information and pricing.

### TECHNICAL DATA & DIMENSIONS

MODEL	WATTAGE	OPERATING VOLTAGE	TOTAL LUMENS	EFFICACY (Lm/W)	CRI	CCT	DIMENSIONS
SHI-1	10W	AC 120-277V	1,400	140	>70	2200K-7000K	13.08" x 8.98" x 5.71"
SHI-2	20W	AC 120-277V	2,800	140	>70	2200K-7000K	
SHI-3	30W	AC 120-277V	4,200	140	>70	2200K-7000K	
SHI-4	40W	AC 120-277V	5,600	140	>70	2200K-7000K	

### SHIELD ORDERING INFORMATION

SAMPLE ORDER NUMBER: SHI-2-1-3-1-1-1-3-OPEB

SERIES	WATTAGE	VOLTAGE	CCT	OPTIC	DRIVER	WARRANTY	OPTIONS	MOUNTING/ACCESSORIES
SHI	1- 10W	1- AC120-277V	1- 3000K	1- 120°	1- 0-10V Dim	5- 5 Year	X- None	X- None
	2- 20W	2- 12-36VDC	2- 4000K	2- 90°	2- Non-Dim	10- 10 Year	1- Flat Glass Lens	OPEM- Junction Box
	3- 30W		3- 5000K	3- 60°			2- Clear Globe	OPCM- Ceiling/Surface Mount Junction Box 3/4" NPT
	4- 40W		4- 6000K	4- 40°			3- Frosted Globe	OPWA- 90° Wall Mount
							4- Wire Guard	
							5- Clear Globe w/ Wire Guard	
							6- Frosted Globe w/ Wire Guard	
							7- Dome Reflector	
							8- Angle Reflector	
							9- Buy American Act Compliant	
							10- Trade Agreements Act Compliant	



# VANGUARD Series LED

Technical Specifications

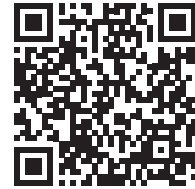

## FEATURES

- > Finish: Powder Coat
- > Lens: Polycarbonate
- > LED Chips: LED 3030
- > Driver: Inventronics / MOSO
- > Expected Life: 244,000 hrs
- > Rating: IP66 & IK08
- > Three wattages available: 150W, 200W, 240W
- > Up to 150lm/W, lumen packages from 22,500lm / 30,000lm / 36,000lm
- > Color temperatures: 2000K - 6500K
- > Colored LED available: R/G/B/AMBER options
- > Wildlife Friendly for coastal areas.
- > Diversified light distributions to meet various applications
- > Double cable entry available - easy mounting
- > Equipped with low copper aluminum alloy body, special powder coating, stainless steel components, and hot-dip galvanized: all these anti-corrosion characteristics make the VANGUARD Series suitable for marine applications
- > LED chips are separated from the driver cavity ensuring exceptional heat dissipation and longer life span
- > Cover on the driver box is designed for anti-dislodging
- > Easy wiring with self-locking spring terminals
- > Ambient temperature:
  - 150W: -40°C to 65°C (-40°F to 149°F)
  - 200W: -40°C to 60°C (-40°F to 140°F)
  - 240W: -40°C to 50°C (-40°F to 122°F)
- > Housing: Aluminum Alloy (less than 0.4% copper content)
- > Surge Protection: 10kV line-line, 10kV line-earth
- > Color Rendering Index (CRI): 70/80/90

## CERTIFICATIONS AND LISTINGS UL:

- > Class I, Division 2, Groups A, B, C, D
- > Class II, Division 1, Groups E, F, G
- > Class II, Division 2, Groups F, G
- > Class III
- > NEMA 4X
- > UL 1598 - Wet Locations | UL 1598A - Marine | UL 8750 - LED Safety | UL 844 - Hazardous Locations

## CSA Standard

- > CSA C22.2 No. 137
- > CSA C22.2 No. 250.0

## APPLICATIONS

- > Power Plants
- > Storage Facilities
- > Paper Mills
- > Waste Water Treatment Plants
- > Heavy Industrials
- > Loading Docks
- > Shipyards
- > Chemical Processing Facilities
- > Petrochemical Processing Facilities

## LUMINOUS OUTPUT & DIMENSIONS

WATTAGE (W)	LUMENS (Lm)	DIMENSIONS
150W	22,500 Lm	22.32" x 18.62" x 6.86"
200W	30,000 Lm	
240W	36,000 Lm	

## VANGUARD ORDERING INFORMATION

SERIES	WATTAGE	VOLTAGE	CCT	OPTICAL	CRI	ACCESSORIES	RATING	WARRANTY
VAN	15- 150W	1- 120-277V	1- 3000K	See Photometrics Codes Spec Sheet via QR Code	1- 70	X- None	1- Hazardous UL844	5- 5 Year
	20- 200W	2- 277-480V	2- 4000K		2- 80	1- Visor	2- Marine 1598A	10- 10 Year
	24- 240W		3- 5000K		3- 90	2- Wire Guard	3- Wet Location 1598	
		R- Red						
		G- Green						
		B- Blue						
		A- Amber						

SAMPLE ORDER NUMBER: VAN-15-1-01606-2-X-1-5

# EVAC Series LED

Technical Specifications

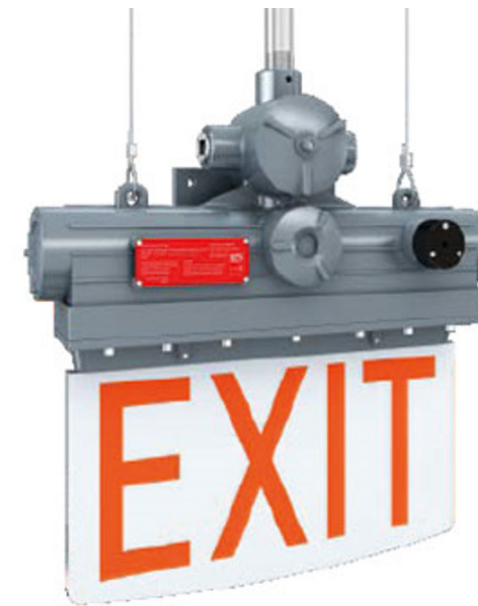
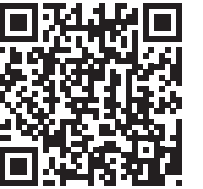

## FEATURES

- > High durability and reliability
- > Label content customizable
- > Low working wattage for energy saving
- > 3/4" NPT or M25 conduit hubs
- > Pendant, wall and end bracket mounts provide universal installation options. Glass sign panel makes cleaning easy
- > Long lifespan: Up to 50,000 hours
- > Operating Temperature: -40°F to 140°F
- > Emergency Battery included (90 minutes)

## MATERIALS

- > Housing: A356T6 Aluminum with baked epoxy finish
- > Sign Panel: Tempered Glass (Transparent)
- > Letters: Red (std) or Green
- > Weight: 13.23LBS.
- > Gasket: One-piece Silicone
- > Hardware: Stainless Steel (including hangers)

## RATINGS/CLASSIFICATIONS

- > Marking UL844
- > Class I, Division 1, Groups B, C, D
- > Class I, Division 2, Groups A, B, C, D
- > Class II, Division 1, Groups E, F, G
- > Class II, Division 2, Groups F, G
- > Class III
- > Marking Marine UL924
- > Other: Wet Location

## APPLICATIONS

- > Power Plants / Heavy Industrials
- > Distillery, Alcohol
- > Paper Mills / Wastewater Treatment Plants
- > Loading Docks / Platforms / Shipyards
- > Chemical Processing Facility
- > Petrochemical Processing Facility
- > Mining
- > Ocean Marine
- > LNG facilities

## DIMENSIONS

Length	16.42"
Width	4.57"
Height	16.74"

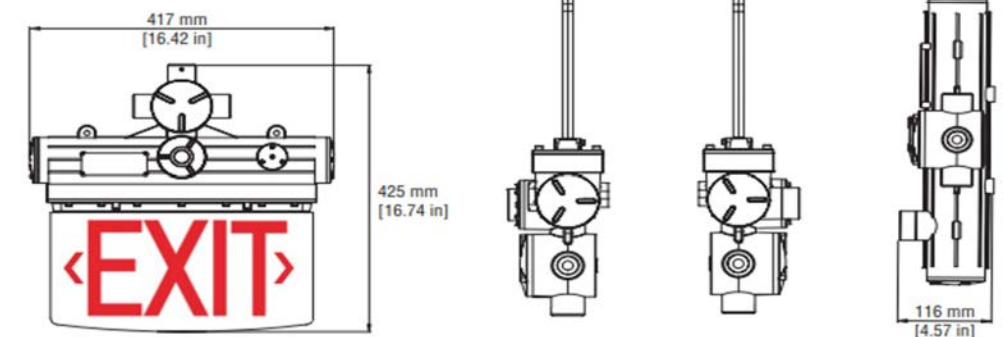

## EVAC ORDERING INFORMATION

SAMPLE ORDER NUMBER: EVA-3-1-1-2

SERIES	WATTAGE	LETTERS	VOLTAGE	OPTIONS
EVA	3- 3W	1- Red	1- 120-277V	1- Wall Mount
	5- 5W	2- Green		2- Pendant Mount





## BACKED WITH CONFIDENCE. INSTALLED BY YOU.



### PRODUCTS MADE IN AMERICA

- > First industrial lighting manufacturer to offer American-made products
- > Shortens lead times
- > Get American quality not foreign tariffs



### REFURBISHMENT PROGRAM

- > Lowest life cycle cost
- > Low LED & driver running temperatures
- > Rugged military-grade design
- > Quality materials, components and construction

245° F

### HIGHER HEAT RATINGS

- > Fixtures rated up to 125°F, 195°F, and 245°F
- > Up to a 30% increase compared to leading competitors
- > Unlike competitors, there's no fall-off in lumen output as heat limit is approached

195° F

125° F

### PATENT PENDING DESIGNS

- > Sets new standards for cooling efficiency over the life of the fixture
- > Innovative, vertical exterior cooling fin dissipates heat while preventing dust and debris build-up
- > Internal cooling fins provide additional protection against dust and debris

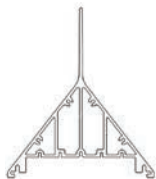

## THE TACTIK ADVANTAGE

At Tactik Lighting,  
we do things differently.

Our team has decades  
of experience helping  
hundreds of clients.

We've seen what doesn't work  
and we refuse to do it that way.

Our standards are set high  
only to deliver the very best  
products to our clients.



3115 N 21<sup>st</sup> Street, Suite 2,  
Sheboygan, WI 53083  
920-287-3840  
sales@tactik.com

[tactiklighting.com](http://tactiklighting.com)

